

Construction

Close-coupled centrifugal pumps; electric motor with extended shaft directly connected to the pump. Pump casing with axial suction and radial delivery on top, main dimensions and performance according to EN 733.

NM: version with pump casing and lantern bracket in cast iron.
 B-NM: version with pump casing and lantern bracket in bronze.
 (the pumps are supplied fully painted).

Connections: Flanges according to PN 10, EN 1092-2.

Counter-flanges (on request)

| Sizes | Flanges |
|------------------------------|--------------------------------------|
| from NM 32/... to NM 50/... | Screwed flanges EN 1092-1, PN 16 |
| from NM 65/... to NM 100/250 | Flanges for welding EN 1092-1, PN 10 |

Applications

- For clean liquids without abrasives, which are non-aggressive for the pump materials (solids content up to 0.2%).
- For water supply.
- For heating, air conditioning, cooling and circulation plants.
- For civil and industrial applications.
- For fire fighting applications. - For irrigation.

Operating conditions

Liquid temperature from -10 °C to +90 °C.
 Ambient temperature up to 40° C.
 Total suction lift up to 7 m.
 Maximum permissible working pressure up to 10 bar.
 Continuous duty.

Motor

2-pole induction motor, 50 Hz (n = 2900 rpm).
NM: three-phase 230/400 V ± 10% up to 3 kW;
 400/690 V ± 10% from 4 to 75 kW.
 Insulation class F. Protection IP 54.
 Constructed in accordance with EN 60034-1.

Special features on request

- Other voltages. - Frequency 60 Hz (as per 60 Hz data sheet).
- Protection IP 55.- Special mechanical seal.
- Packed gland (only for NM standard construction).
- Single-phase motor (NMM) up to 1.5 kW.
- Explosion proof construction in accordance with Directive 94/9 EEC (ATEX).
- Higher or lower liquid or ambient temperatures.

Materials

| Components | NM | B-NM |
|-----------------|---|----------------------------|
| Pump casing | Cast iron | Bronze |
| Lantern bracket | GJL 200 EN 1561 | G-Cu Sn 10 EN 1982 |
| Impeller | Cast iron | Bronze |
| | GJL 200 EN 1561 | G-Cu Sn 10 EN 1982 |
| | Brass P- Cu Zn 40 Pb 2 UNI 5705 for NM 32/12-16-20, NM 40/20 B-NM 32/125-160-200, B-NM 40/200 | |
| Shaft | Cr Ni steel AISI 303 up to 2.2 kW | Cr Ni Mo steel AISI 316 |
| | Cr steel AISI 430 from 3 kW to 75 kW | |
| Mechanical seal | Carbon - Ceramic - NBR | |
| Counter-flanges | Steel Fe 430B UNI 7070 | |

Coverage chart n ≈ 2900 rpm

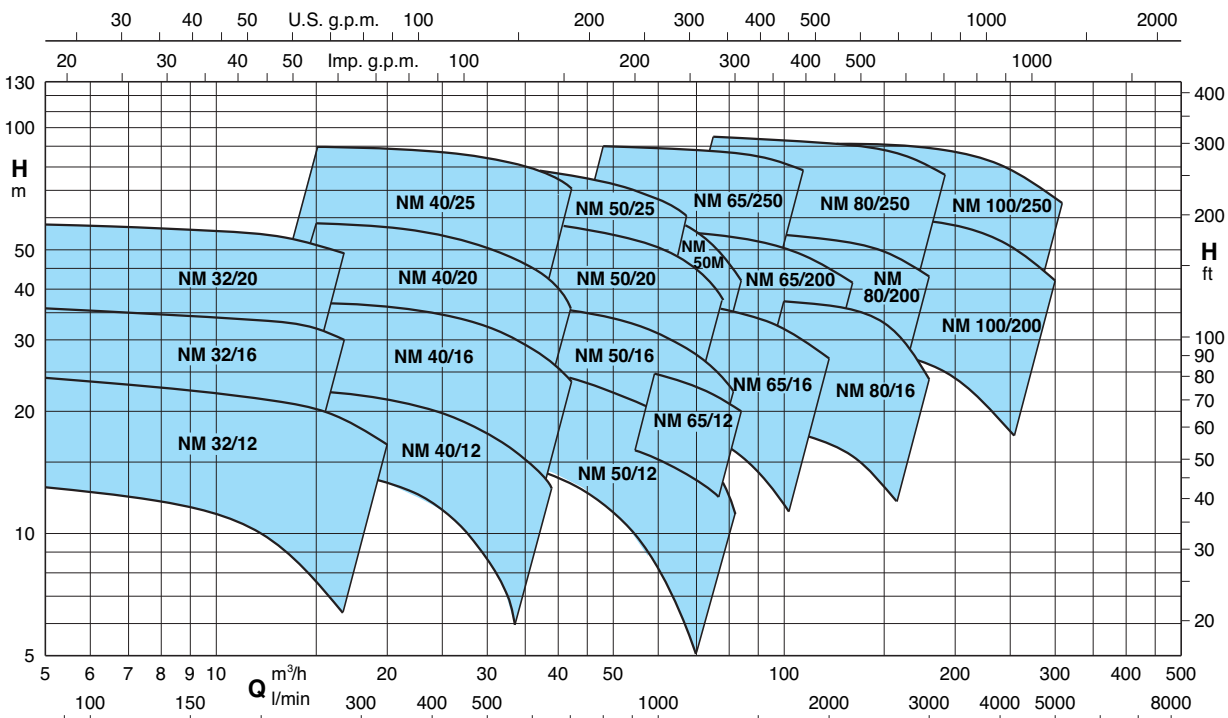

Performance n ≈ 2900 rpm

| B-NM | NM | P ₂ | | Q m ³ /h l/min | 6,6 | 7,5 | 8,4 | 9,6 | 10,8 | 12 | 13,2 | 15 | 16,8 | 18,9 | 21 | 24 | 27 | 30 |
|-------------|------------|----------------|------|---------------------------------|----------------|------|------|------|------|------|------|------|------|-------|-------|-----|-----|-----|
| | | kW | HP | | 110 | 125 | 140 | 160 | 180 | 200 | 220 | 250 | 280 | 315 | 350 | 400 | 450 | 500 |
| | | | | | H _m | | | | | | | | | | | | | |
| B-NM 32/12F | NM 32/12FE | 0,55 | 0,75 | | 12,5 | 12,5 | 12 | 11,5 | 11 | 10 | 9 | 7,5 | | | | | | |
| B-NM 32/12D | NM 32/12DE | 0,75 | 1 | | 18 | 18 | 17,5 | 17 | 16,5 | 16 | 15,5 | 14 | | | | | | |
| B-NM 32/12A | NM 32/12AE | 1,1 | 1,5 | | 23 | 23 | 22,5 | 22 | 21,5 | 21 | 20,5 | 19 | | | | | | |
| B-NM 32/12S | NM 32/12SE | 1,5 | 2 | | 23,5 | 23,5 | 23 | 22,5 | 22 | 21,5 | 21 | 20,5 | | | | | | |
| B-NM 32/16B | NM 32/16BE | 1,5 | 2 | | 29,5 | 29,5 | 29 | 28,5 | 27,5 | 27 | 26 | 25* | 19* | 18,5* | 16,5* | 13* | | |
| B-NM 32/16A | NM 32/16AE | 2,2 | 3 | | 35,5 | 35,5 | 35 | 34,5 | 34 | 33,5 | 33 | 32* | 30* | | | | | |
| B-NM 32/20D | NM 32/20DE | 2,2 | 3 | | 38 | 37,5 | 37 | 36 | 35 | 33,5 | 32 | | | | | | | |
| B-NM 32/20C | NM 32/20CE | 3 | 4 | | 45 | 44,5 | 44 | 43,5 | 42,5 | 41 | 40 | 38 | 36* | | | | | |
| B-NM 32/20A | NM 32/20AE | 4 | 5,5 | | 57,5 | 57 | 56 | 55,5 | 55 | 54,5 | 53,5 | 51,5 | 49* | | | | | |

| B-NM | NM | P ₂ | | Q m ³ /h l/min | 15 | 16,8 | 18,9 | 21 | 24 | 27 | 30 | 33 | 37,8 | 39 | 42 | 45 | 48 | 54 |
|---------------|-------------|----------------|------|---------------------------------|----------------|------|------|------|------|------|------|------|------|------|------|-----|-----|-----|
| | | kW | HP | | 250 | 280 | 315 | 350 | 400 | 450 | 500 | 550 | 630 | 650 | 700 | 850 | 800 | 900 |
| | | | | | H _m | | | | | | | | | | | | | |
| B-NM 40/12F | NM 40/12F/A | 1,1 | 1,5 | | 14 | 13,5 | 13 | 12 | 11 | 9,5 | 8 | 6 | | | | | | |
| B-NM 40/12C | NM 40/12C/A | 1,5 | 2 | | 17,5 | 17 | 16,5 | 16 | 15 | 13,5 | 12 | 10,5 | 7,5 | 6,5 | | | | |
| B-NM 40/12A | NM 40/12A/A | 2,2 | 3 | | 22 | 22 | 21,5 | 21 | 20 | 19 | 18 | 16,5 | 14 | 13 | 11,5 | | | |
| B-NM 40/16C | NM 40/16C/A | 2,2 | 3 | | 23 | 22,5 | 22 | 21,5 | 20 | 18,5 | 16,5 | 14,5 | 11 | 10 | | | | |
| B-NM 40/16B | NM 40/16B/A | 3 | 4 | | 29 | 28,8 | 28 | 27,5 | 26,5 | 25 | 23,5 | 21,5 | 18 | 17 | 14 | | | |
| B-NM 40/16A | NM 40/16A/A | 4 | 5,5 | | 37 | 36,5 | 36,5 | 36 | 35 | 33,5 | 32 | 30,5 | 27 | 26 | 23,5 | 20 | 17 | |
| B-NM 40/20D | NM 40/20DE | 4 | 5,5 | | 39 | 38 | 37 | 35,5 | 33,5 | 30,5 | 27 | 22,5 | 14 | | | | | |
| B-NM 40/20C | NM 40/20CE | 4 | 5,5 | | 41,5 | 40,5 | 39,5 | 38 | 36 | 33,5 | | | | | | | | |
| B-NM 40/200BE | NM 40/20BE | 5,5 | 7,5 | | 50 | 49,5 | 48,5 | 47,5 | 45,5 | 43,5 | 41,5 | 37,5 | 30,5 | | | | | |
| | NM 40/20ARE | 5,5 | 7,5 | | 55 | 54,5 | 54 | 53 | 51 | 49 | | | | | | | | |
| B-NM 40/200AE | NM 40/20AE | 7,5 | 10 | | 57,5 | 57 | 56,5 | 55,5 | 54,5 | 52,5 | 50,5 | 48 | 42,5 | 40,5 | 35 | | | |
| B-NM 4025/C/A | NM 40/25C/A | 9,2 | 12,5 | | 61 | 61 | 60,5 | 59,5 | 58,5 | 56,5 | 53,5 | 49,5 | 41,5 | 40 | 33,5 | | | |
| B-NM 4025/B/A | NM 40/25B/A | 11 | 15 | | 69,5 | 69,5 | 69 | 68,5 | 67 | 65,5 | 63,5 | 60,5 | 53,5 | 51 | 45 | | | |
| B-NM 4025/A/A | NM 40/25A/A | 15 | 20 | | 90 | 90 | 89,5 | 89 | 88,5 | 87 | 85 | 83 | 77,5 | 76 | 70,5 | | | |

| B-NM | NM | P ₂ | | Q m ³ /h l/min | 24 | 27 | 30 | 33 | 37,8 | 42 | 48 | 54 | 60 | 66 | 69 | 72 | 75 | 78 | 81 | 84 |
|----------------|-------------|----------------|------|---------------------------------|----------------|------|------|------|------|------|------|------|------|------|------|------|------|------|------|------|
| | | kW | HP | | 400 | 450 | 500 | 550 | 630 | 700 | 800 | 900 | 1000 | 1100 | 1150 | 1200 | 1250 | 1300 | 1350 | 1400 |
| | | | | | H _m | | | | | | | | | | | | | | | |
| B-NM 50/12F | NM 50/12F/A | 2,2 | 3 | | | | 15,5 | 15 | 14 | 13,5 | 12 | 10 | 8 | 6 | | | | | | |
| B-NM 50/12D | NM 50/12D/A | 3 | 4 | | | | 20 | 19,5 | 18,5 | 18 | 16,5 | 14,5 | 13 | 10,5 | 9 | 8 | | | | |
| B-NM 50/12A | NM 50/12A/A | 4 | 5,5 | | | | 24 | 24 | 23 | 22,5 | 21 | 19,5 | 17,5 | 15 | 14 | 12,5 | 11,5 | 10 | | |
| B-NM 50/12S | NM 50/12S/A | 4 | 5,5 | | | | 26,5 | 26 | 25,5 | 24,5 | 23,5 | 22 | 20 | 18 | 16,5 | 15,5 | 14 | 13 | 11 | |
| B-NM 50/160B/A | NM 50/16B/A | 5,5 | 7,5 | | | | 31 | 30,5 | 29,5 | 28 | 26 | 24 | 21,5 | 19 | 17,5 | 15,5 | 13,5 | 11,5 | 9,5 | |
| B-NM 50/160A/A | NM 50/16A/A | 7,5 | 10 | | | | 38,5 | 38 | 37,5 | 36,5 | 34,5 | 32,5 | 30 | 27 | 25,5 | 24 | 22,5 | 20,5 | 19 | |
| B-NM 50/200B/A | NM 50/20B/A | 9,2 | 12,5 | | 48 | 47,5 | 47,5 | 47 | 45,5 | 44,5 | 42,5 | 40 | 37 | 33 | 30,5 | 28 | 25,5 | 23 | | |
| B-NM 50/200A/A | NM 50/20A/A | 11 | 15 | | 55 | 55 | 54,5 | 54,5 | 53,5 | 52 | 50 | 48 | 45 | 41,5 | 39,5 | 37 | 35 | 32,5 | | |
| B-NM 50/200S/A | NM 50/20S/A | 15 | 20 | | 60 | 60 | 59,5 | 59,5 | 58,5 | 57,5 | 55,5 | 53,5 | 50,5 | 47 | 45 | 43 | 40,5 | 37 | | |
| B-NM 5025/C/A | NM 50/25C/A | 11 | 15 | | 55 | 54,5 | 54 | 53 | 51,5 | 49,5 | 46 | 41,5 | 35,5 | 28,5 | 24,5 | | | | | |
| B-NM 5025/B/A | NM 50/25B/A | 15 | 20 | | 69 | 68,5 | 68 | 67,5 | 66 | 64 | 61 | 57 | 52,5 | 46,5 | 43 | | | | | |
| B-NM 5025/A/A | NM 50/25A/A | 18,5 | 25 | | 80,5 | 80,5 | 80 | 79,5 | 78,5 | 77 | 74,5 | 71,5 | 67 | 61,5 | 58,5 | | | | | |
| B-NM 5025/65EE | NM 50M/EE | 11 | 15 | | | | 48 | 47,5 | 46 | 45 | 43 | 40 | 37 | 32 | 29,5 | 27 | 24 | | | |
| B-NM 5025/65DE | NM 50M/DE | 15 | 20 | | | | 57 | 56,5 | 56 | 55 | 53 | 51 | 48 | 44,5 | 42 | 39,5 | 37 | 32 | 29 | 25* |
| B-NM 5025/65CE | NM 50M/CE | 18,5 | 25 | | | | 68 | 67,5 | 67 | 66,5 | 65 | 63 | 61 | 58 | 56 | 53,5 | 51,5 | 48 | 45,5 | 42* |

| B-NM | NM | P ₂ | | Q m ³ /h l/min | 37,8 | 42 | 48 | 54 | 60 | 66 | 75 | 84 | 96 | 108 | 120 | 132 | 150 | 168 |
|---------------|-------------|----------------|------|---------------------------------|----------------|------|------|------|------|-------|-------|-------|-------|-------|-------|-------|------|------|
| | | kW | HP | | 630 | 700 | 800 | 900 | 1000 | 1100 | 1250 | 1400 | 1600 | 1800 | 2000 | 2200 | 2500 | 2800 |
| | | | | | H _m | | | | | | | | | | | | | |
| B-NM 65/125CE | NM 65/12CE | 5,5 | 7,5 | | 18 | 17,5 | 17 | 16,5 | 16 | 15 | 13,5* | | | | | | | |
| B-NM 65/125AE | NM 65/12AE | 7,5 | 10 | | 22 | 21,5 | 21 | 20,5 | 20 | 19,5 | 18 | 15,5* | | | | | | |
| B-NM 65/160EE | NM 65/16EE | 5,5 | 7,5 | | | | 20 | 19,5 | 19 | 18,5 | 17 | 15,5 | 13* | 10* | | | | |
| B-NM 65/160DE | NM 65/16DE | 7,5 | 10 | | | | 26 | 25,5 | 25 | 24,5 | 23,5 | 22 | 20* | 16,5* | 13* | | | |
| B-NM 65/160CE | NM 65/16CE | 9,2 | 12,5 | | | | 30 | 29,5 | 29 | 28,5 | 28 | 26,5 | 24,5* | 21,5* | 18* | | | |
| B-NM 65/160BE | NM 65/16BE | 11 | 15 | | | | 33,5 | 33 | 32,5 | 32 | 31 | 30 | 28* | 25,5* | 22* | | | |
| B-NM 65/160AE | NM 65/16AE | 15 | 20 | | | | 38 | 37,5 | 37 | 36,5 | 36 | 35 | 33* | 30,5* | 27* | | | |
| B-NM 65/200CE | NM 65/20CE | 15 | 20 | | | | 44 | 43,5 | 43 | 42,5 | 41 | 39,5 | 37,5* | 35* | 31* | 27* | | |
| B-NM 65/200BE | NM 65/20BE | 18,5 | 25 | | | | 50 | 49,5 | 49 | 48,5 | 47,5 | 46,5 | 44,5* | 42* | 39* | 35* | | |
| B-NM 65/200AE | NM 65/20AE | 22 | 30 | | | | 56,5 | 56 | 55,5 | 55 | 54,5 | 53,5 | 51* | 48,5* | 45,5* | 41,5* | | |
| B-NM 65/250CE | NM 65/250CE | 22 | 30 | | | | 64 | 63,5 | 63 | 61,5* | 60* | 57,5* | 54,5* | 50* | | | | |
| B-NM 65/250BE | NM 65/250BE | 30 | 40 | | | | 79,5 | 79 | 78,5 | 78* | 77* | 75* | 72* | 67* | | | | |
| B-NM 65/250AE | NM 65/250AE | 37 | 50 | | | | 90 | 89,5 | 89 | 88,5* | 87,5* | 86* | 83,5* | 78,5* | | | | |

Performance n ≈ 2900 rpm

| B-NM | NM | P ₂ | | Q m ³ /h l/min | 75 | 84 | 96 | 108 | 120 | 132 | 150 | 168 | 180 | 192 | 210 | 240 | 270 | 300 | | |
|---------------|--------------|----------------|------|---------------------------------|--------|------|------|-------|-------|-------|-------|-------|-------|-------|-------|-------|-------|-------|--|--|
| | | kW | HP | | H m | | | | | | | | | | | | | | | |
| | | | | | 1250 | 1400 | 1600 | 1800 | 2000 | 2200 | 2500 | 2800 | 3000 | 3200 | 3500 | 4000 | 4500 | 5000 | | |
| B-NM 80/160EE | NM 80/16EE | 7,5 | 10 | | 20 | 19,3 | 18,5 | 17,5* | 16,5* | 15,5* | 13* | | | | | | | | | |
| B-NM 80/160DE | NM 80/16DE | 9,2 | 12,5 | | 23 | 22,5 | 22 | 21* | 19,5* | 18* | 15* | | | | | | | | | |
| B-NM 80/160CE | NM 80/16CE | 11 | 15 | | 27,5 | 27 | 26,5 | 25,5* | 24,5* | 23* | 20* | 16* | | | | | | | | |
| B-NM 80/160BE | NM 80/16BE | 15 | 20 | | 34 | 33,5 | 33 | 32,5* | 32* | 31* | 28* | 23* | 18* | | | | | | | |
| B-NM 80/160AE | NM 80/16AE | 18,5 | 25 | | 38,5 | 38 | 37,5 | 37* | 36,5* | 36* | 33* | 29* | 24* | | | | | | | |
| | NM 80/200BE | 22 | 30 | | 46,5 | 46 | 45,5 | 44,5 | 43,5* | 42* | 39* | 35,5* | 32* | | | | | | | |
| | NM 80/200AE | 30 | 40 | | 56 | 55,5 | 55 | 54 | 53* | 52* | 49,5* | 46* | 43* | | | | | | | |
| | NM 80/250EE | 22 | 30 | | 51 | 50 | 48,5 | 46,5 | 44,5* | 42* | 38* | 33* | 29* | | | | | | | |
| | NM 80/250DE | 30 | 40 | | 65 | 64 | 62,5 | 61 | 59* | 56,5* | 53* | 49* | 45,5* | 41* | | | | | | |
| | NM 80/250CE | 37 | 50 | | 73,5 | 73 | 72 | 70,5 | 69* | 67* | 63* | 59* | 55,5* | 51,5* | | | | | | |
| | NM 80/250BE | 45 | 60 | | 84 | 83,5 | 82,5 | 81,5 | 80* | 78* | 74,5* | 70,5* | 67* | 63* | | | | | | |
| | NM 80/250AE | 55 | 75 | | 95 | 94,5 | 93,5 | 92,5 | 91,5* | 90* | 87,5* | 84* | 80,5* | 76,5* | | | | | | |
| | NM 100/200EE | 18,5 | 25 | | | | | 30 | 29,5 | 29 | 28 | 27 | 26* | 25* | 23* | 19* | | | | |
| | NM 100/200DE | 22 | 30 | | | | | 36 | 35,5 | 35 | 34 | 33 | 32* | 31* | 29* | 24,5* | 19* | | | |
| | NM 100/200CE | 30 | 40 | | | | | 45 | 44,5 | 44 | 43,5 | 42,5 | 41,5* | 40,5* | 39* | 34,5* | 29* | 22° | | |
| | NM 100/200BE | 37 | 50 | | | | | 54 | 53,5 | 53 | 52,5 | 51,5 | 50,5* | 49,5* | 48* | 44* | 38,5* | 32° | | |
| | NM 100/200AE | 45 | 60 | | | | | 61,5 | 61 | 60,5 | 60 | 59,5 | 58,5* | 58* | 56,5* | 53* | 48* | 42° | | |
| | NM 100/250BE | 55 | 75 | | | | | 73,5 | 73 | 72,5 | 71,5 | 70 | 68,5* | 67* | 65* | 61* | 55,5* | 48,5° | | |
| | NM 100/250AE | 75 | 100 | | | | | 91 | 90,5 | 90 | 89,5 | 88,5 | 88* | 87* | 85* | 81* | 75* | 67° | | |

NM Standard construction.
B-NM Bronze construction.

P₂ Rated motor power output.
H Total head in m.

* Maximum suction lift 1-2 m.
◦ With 1 m suction head.

Tolerances according to ISO 9906, annex A.

Rated currents

| P ₂ | | 230V Δ / 400V Y 400V Δ / 690V Y | | | IA/IN |
|----------------|------|------------------------------------|------|------|-------|
| kW | HP | IN A | IN A | IN A | |
| 0,55 | 0,75 | 3 | 1,7 | | 4,3 |
| 0,75 | 1 | 4 | 2,3 | | 5,2 |
| 1,1 | 1,5 | 5 | 2,9 | | 5,3 |
| 1,5 | 2 | 7,5 | 4,3 | | 5,8 |
| 2,2 | 3 | 9,15 | 5,3 | | 6 |
| 3 | 4 | 11,5 | 6,6 | | 9 |
| 4 | 5,5 | | 9,6 | 5,5 | 9,3 |
| 5,5 | 7,5 | | 12 | 7 | 8,3 |
| 7,5 | 10 | | 16 | 9,2 | 8,8 |
| 9,2 | 12,5 | | 18,5 | 10,7 | 8,3 |
| 11 | 15 | | 21,5 | 12,4 | 8,4 |
| 15 | 20 | | 27,5 | 15,9 | 8,8 |
| 18,5 | 25 | | 34 | 19,6 | 9,7 |
| 22 | 30 | | 42 | 24,2 | 9 |
| 30 | 40 | | 54 | 31,2 | 9 |
| 37 | 50 | | 68 | 39,5 | 8,5 |
| 45 | 60 | | 85 | 49 | 8 |
| 55 | 75 | | 105 | 60 | 7,2 |
| 75 | 100 | | 140 | 81 | 6 |

P₂ Potenza nominale motore.
IA/IN Corrente di spunto / Corrente nominale.



Characteristic curves $n \approx 2900$ rpm

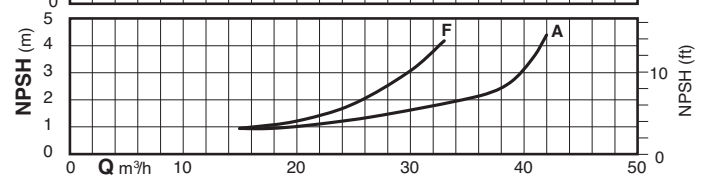
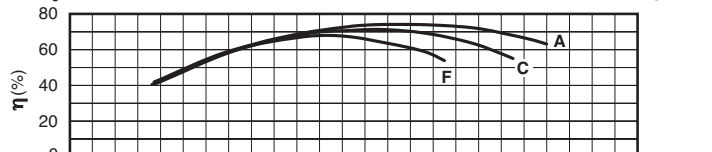
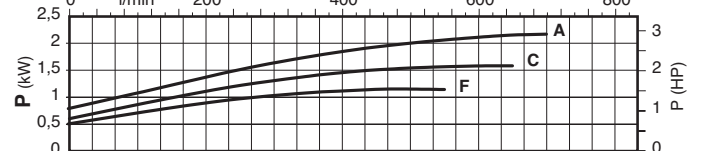
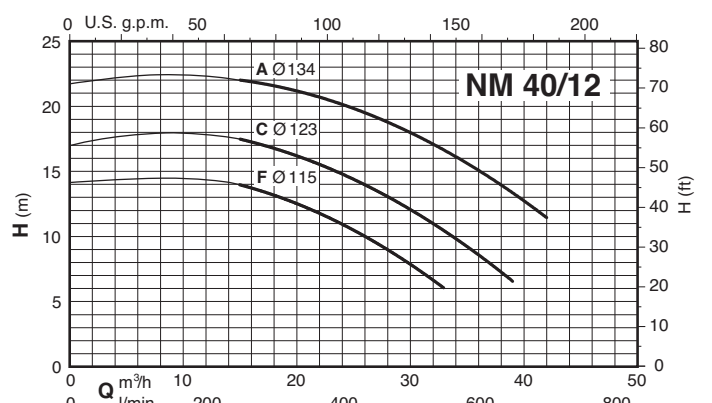
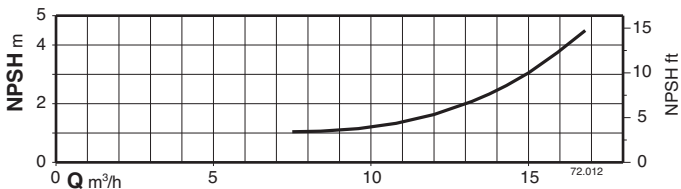
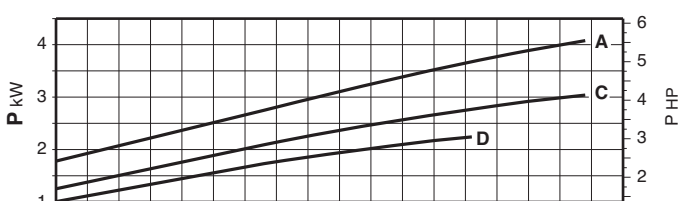
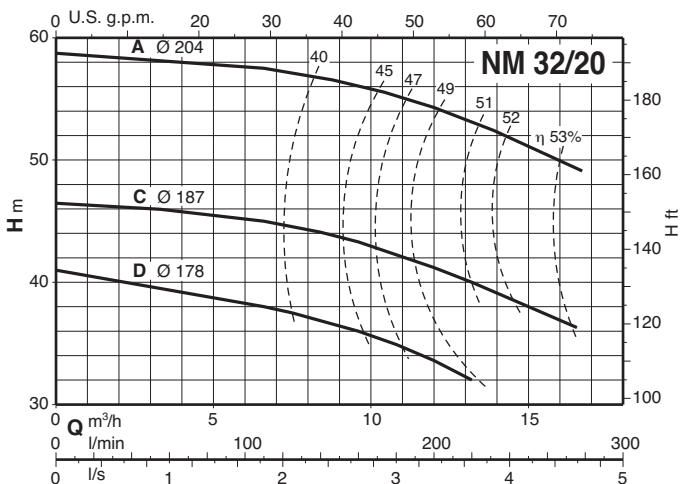
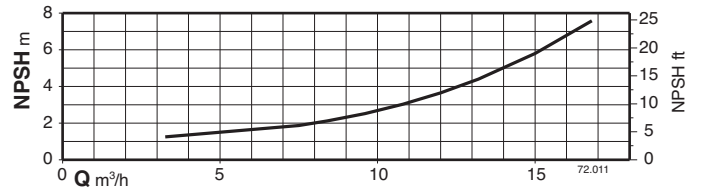
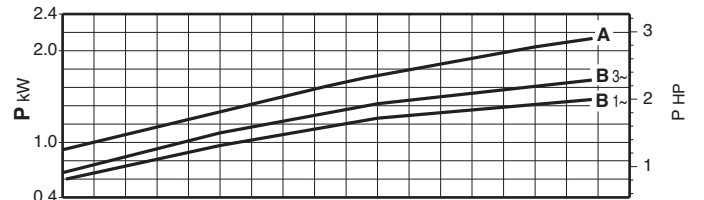
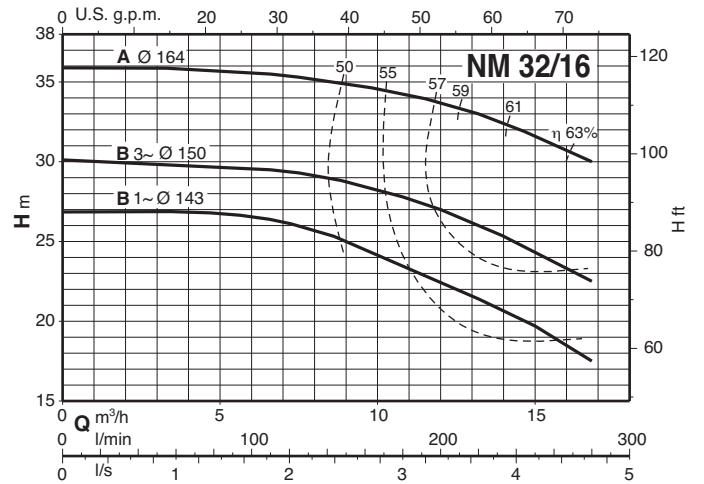
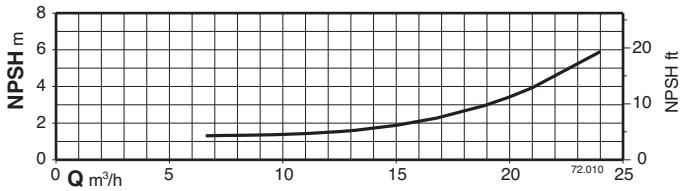
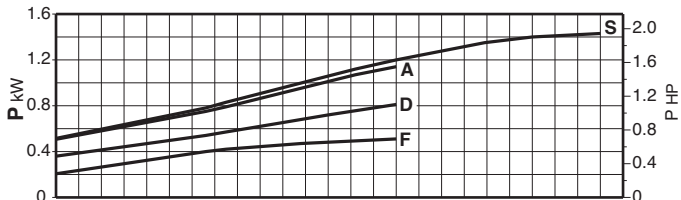
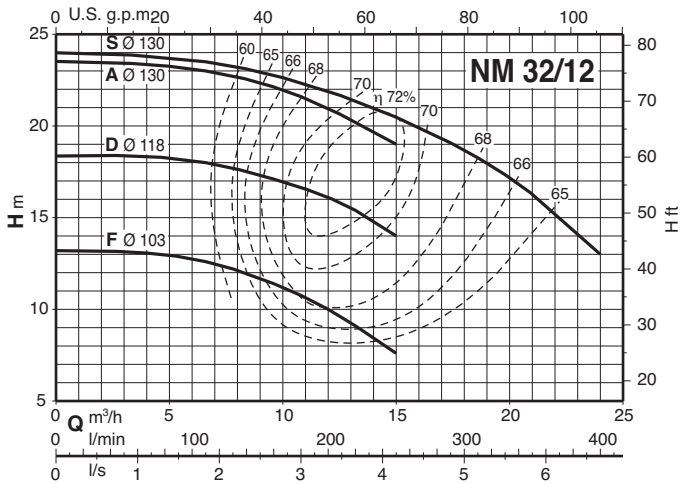

Characteristic curves $n \approx 2900$ rpm

2

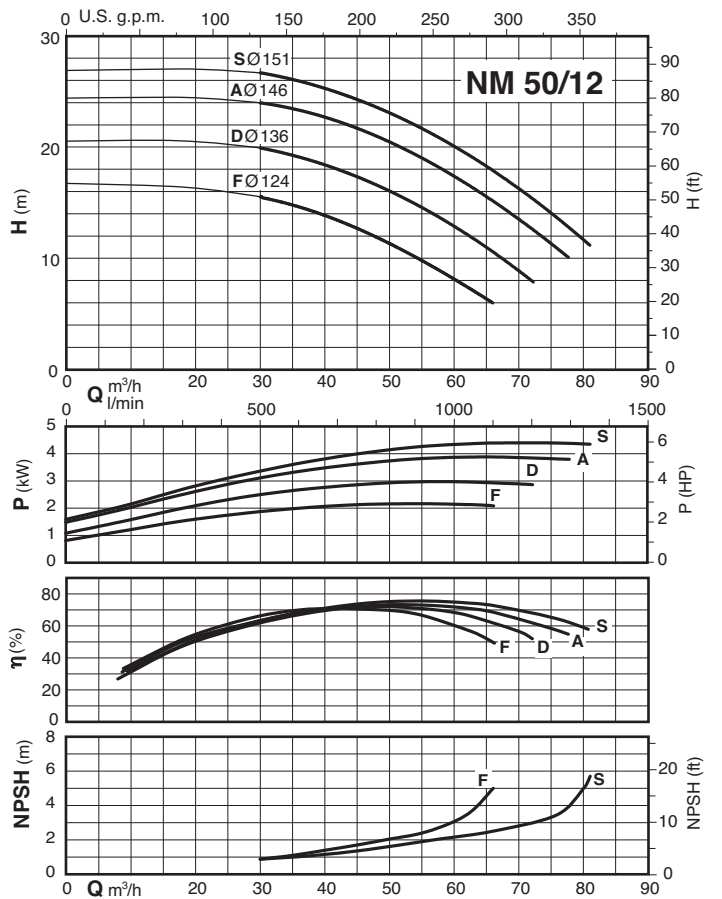
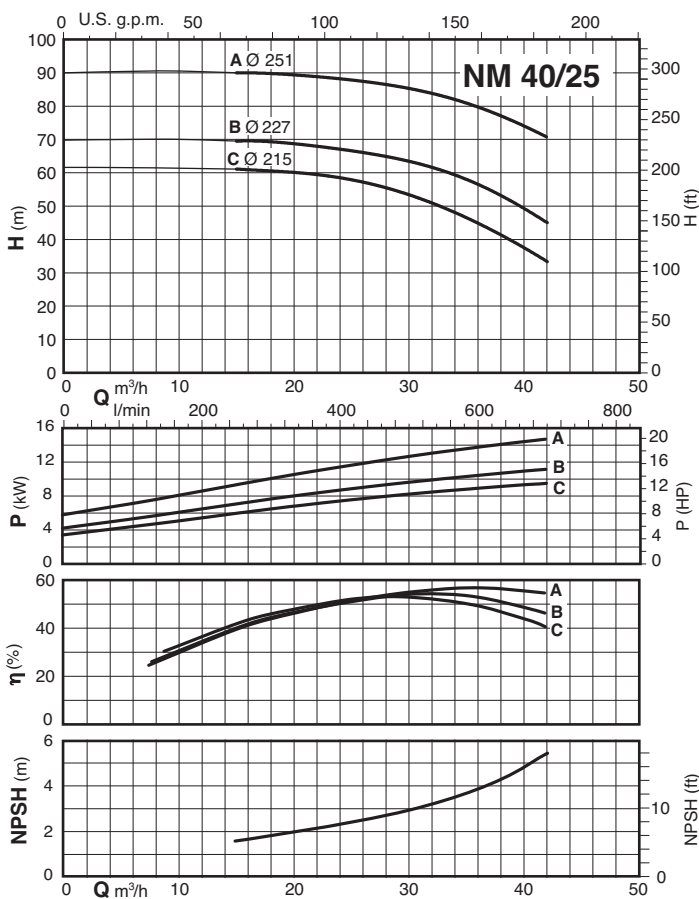
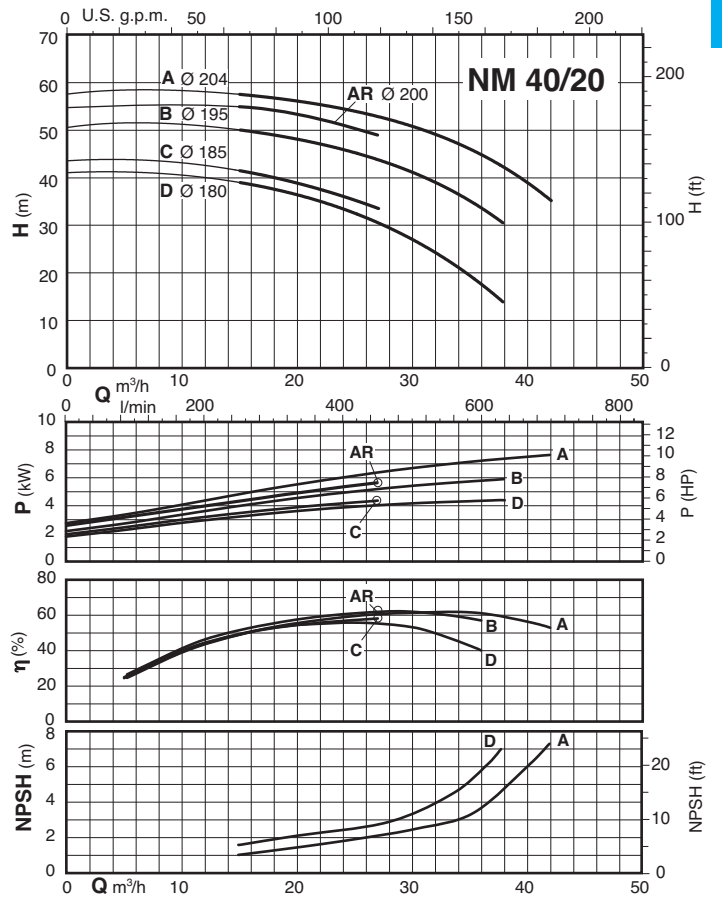
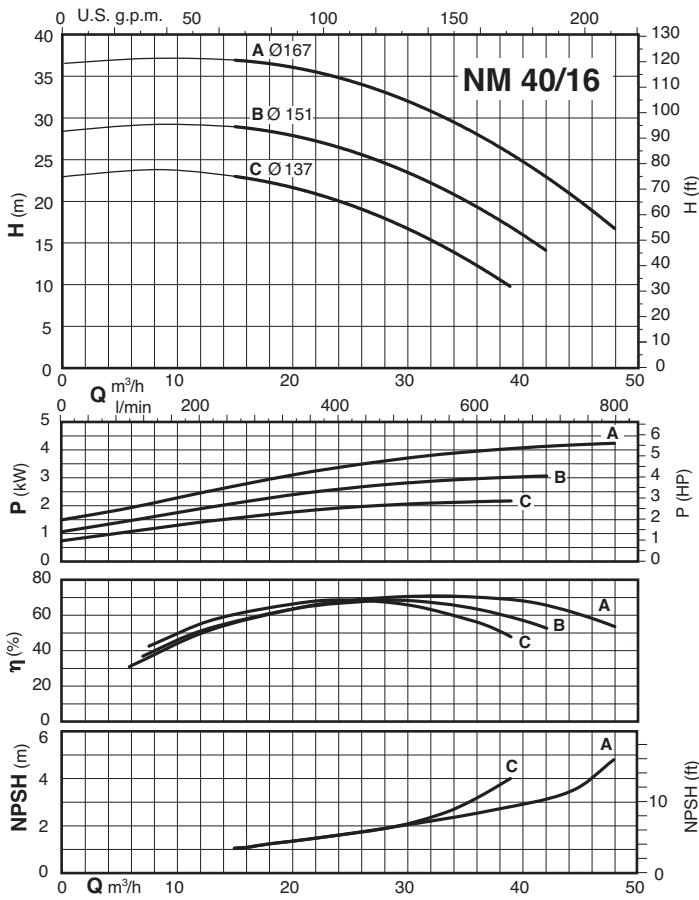

Characteristic curves $n \approx 2900$ rpm

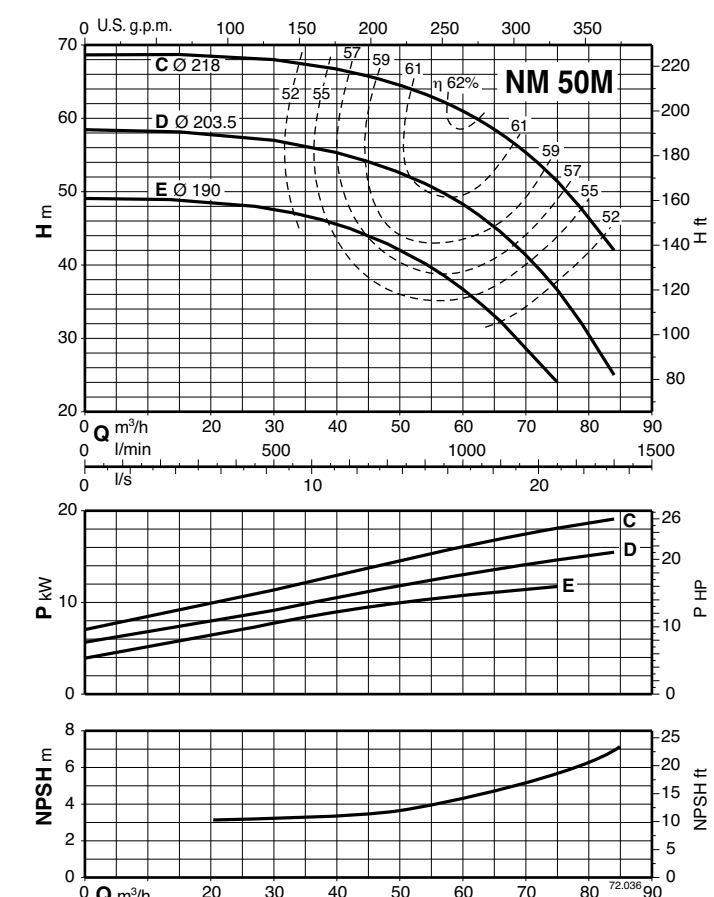
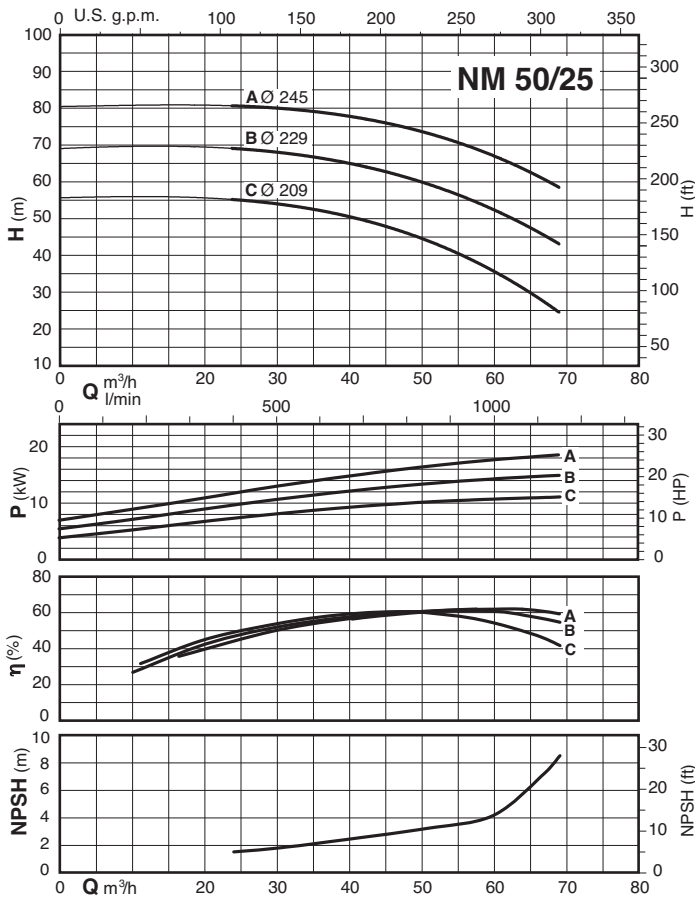
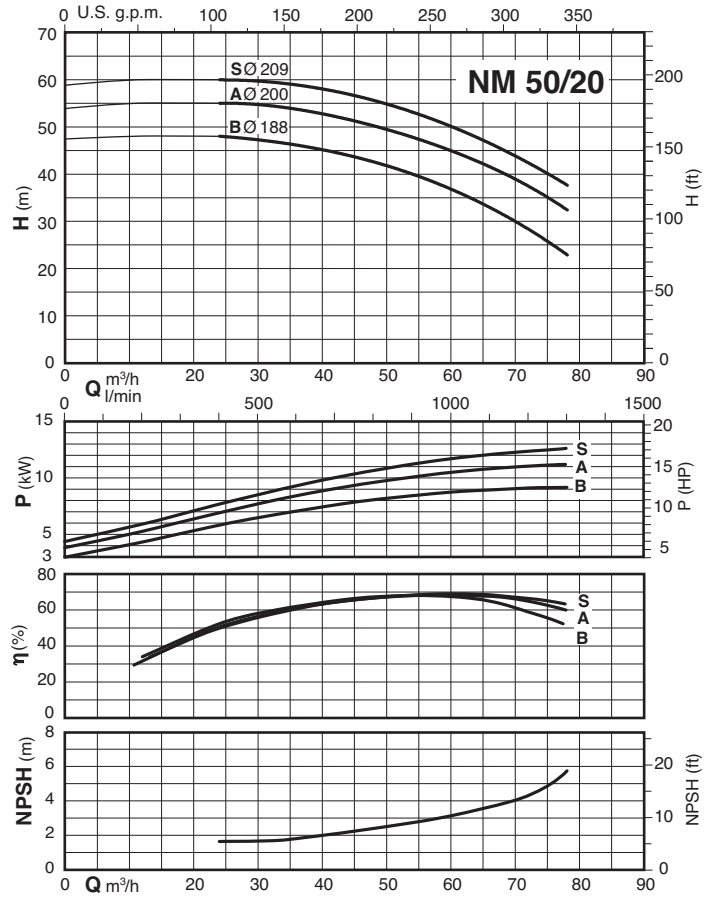
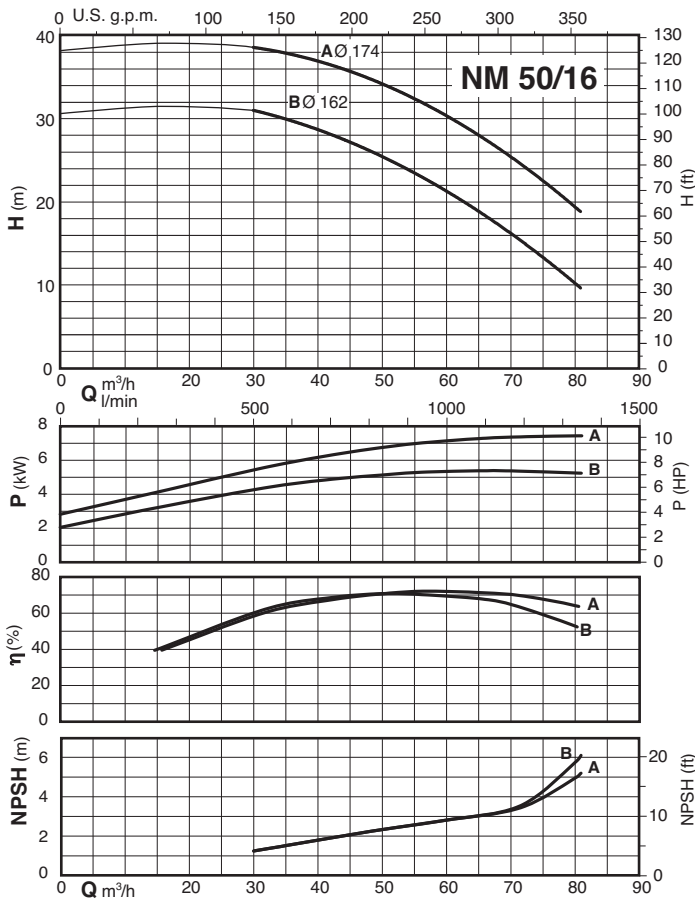

Characteristic curves $n \approx 2900$ rpm

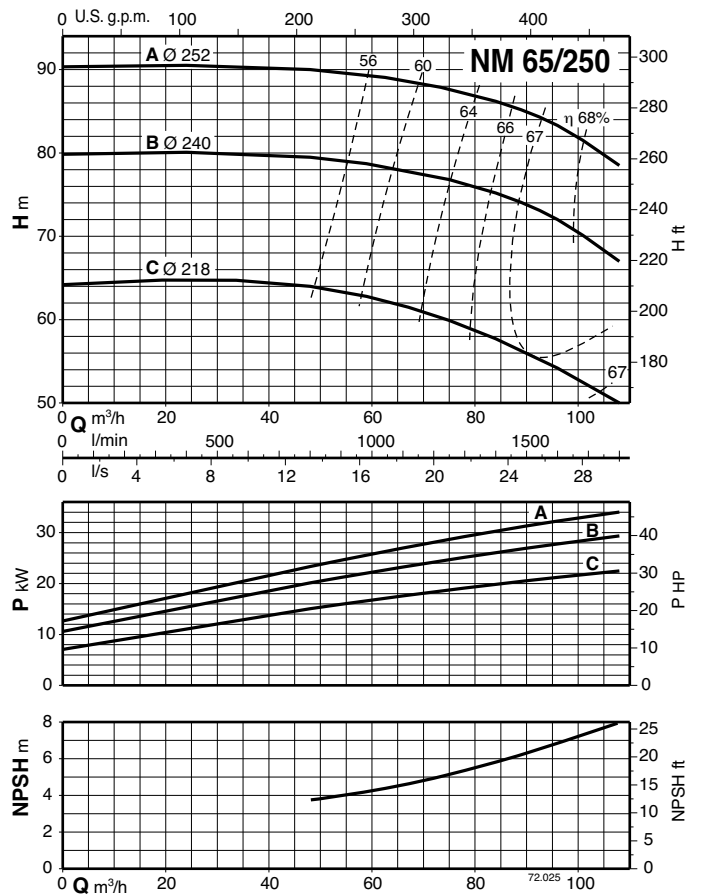
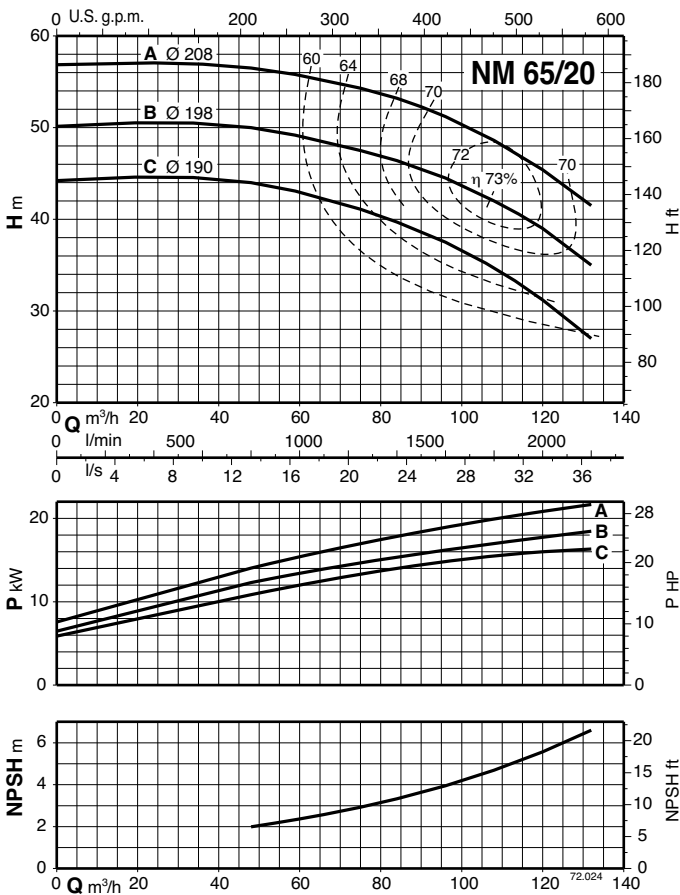
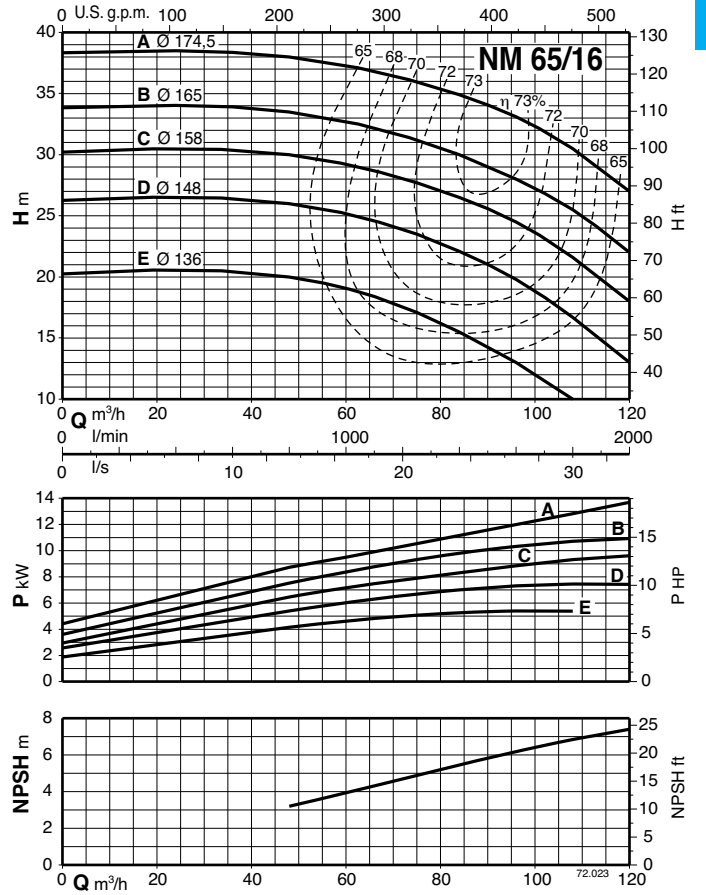
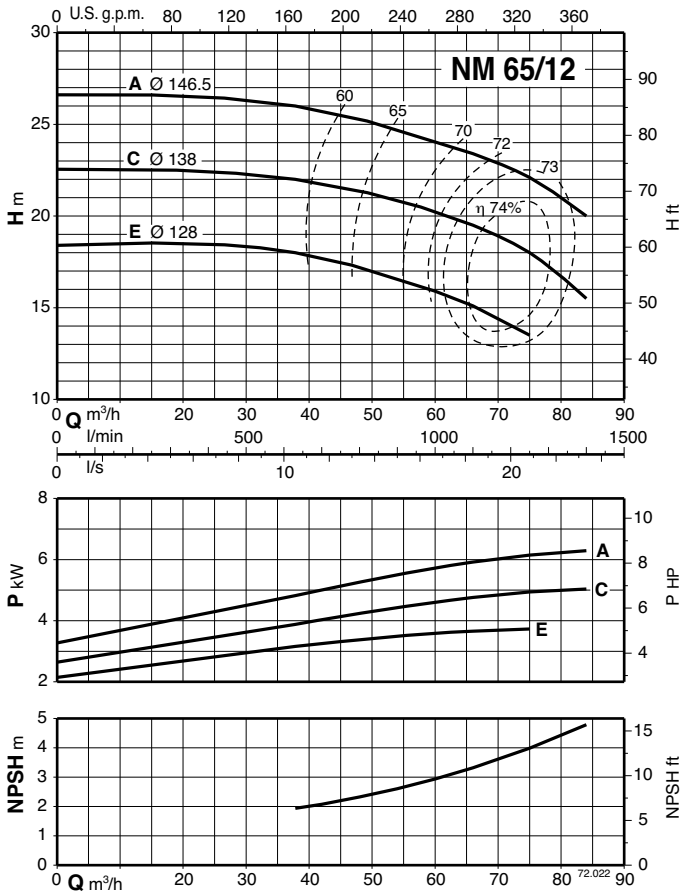

Characteristic curves $n \approx 2900$ rpm

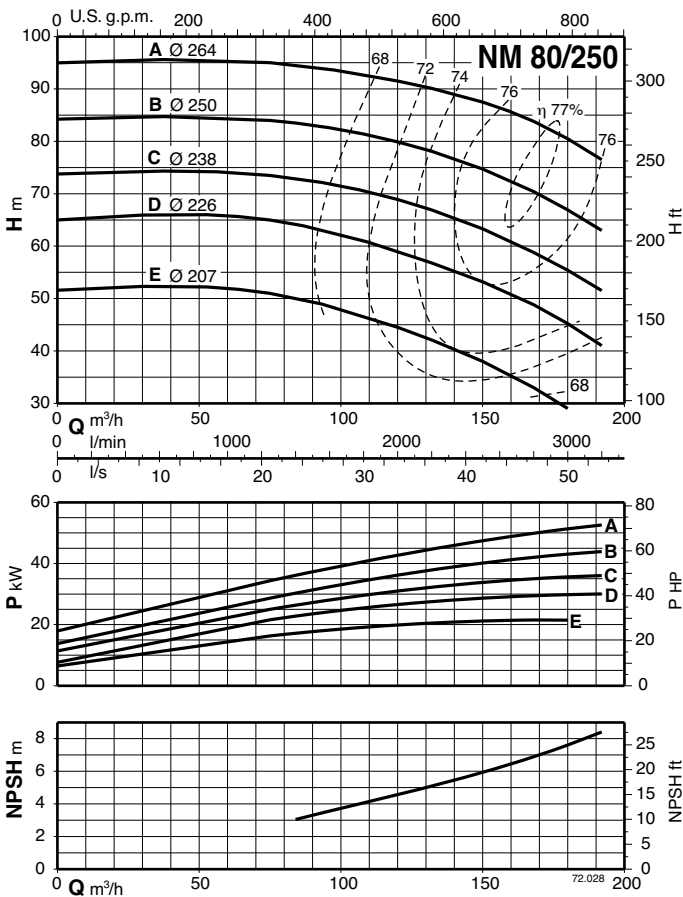
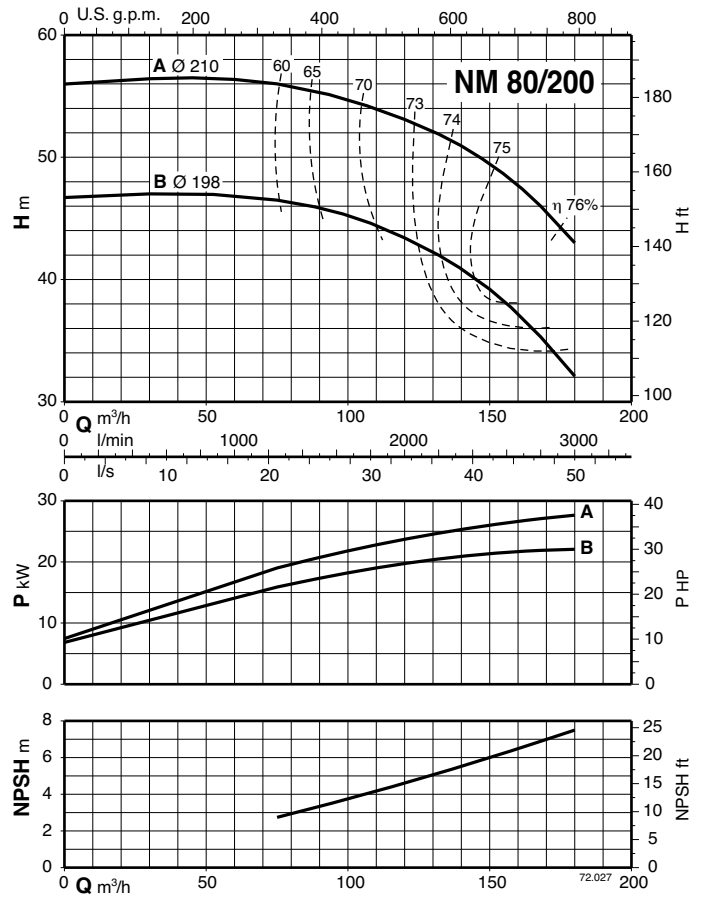
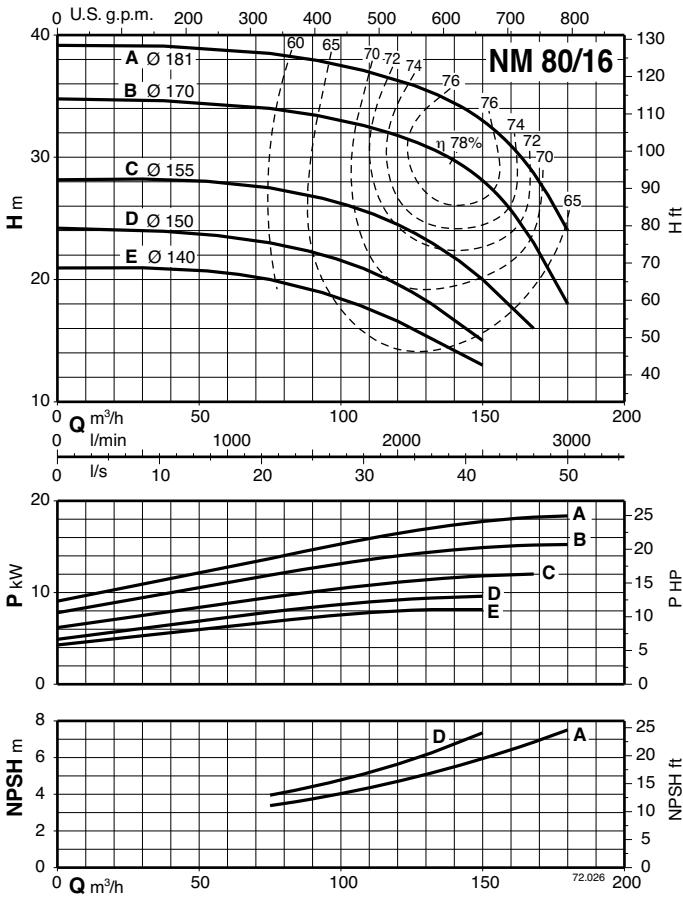

Characteristic curves $n \approx 2900$ rpm

2

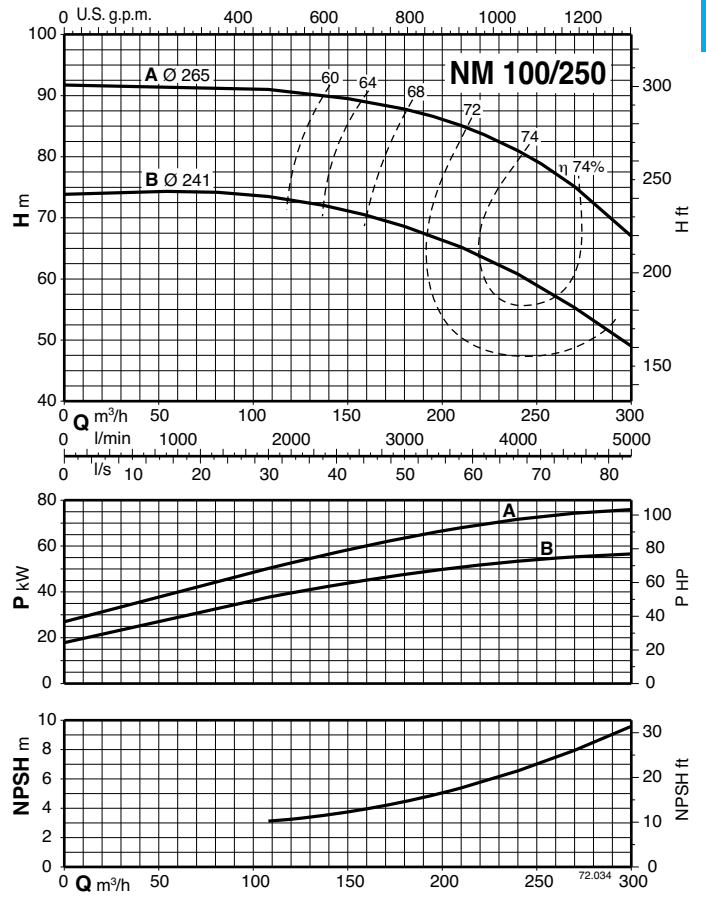
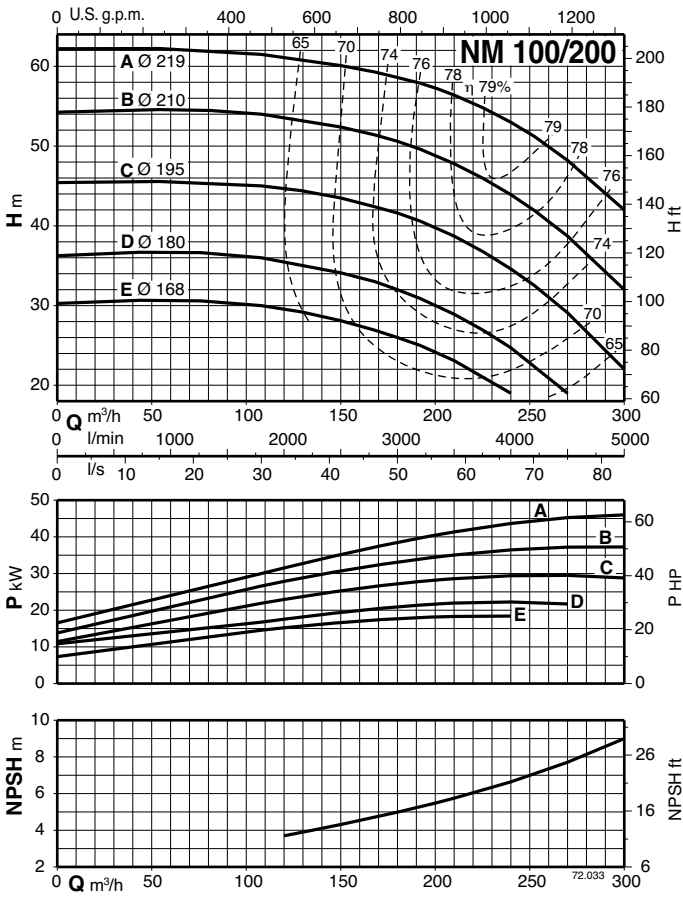

Dimensions and weights

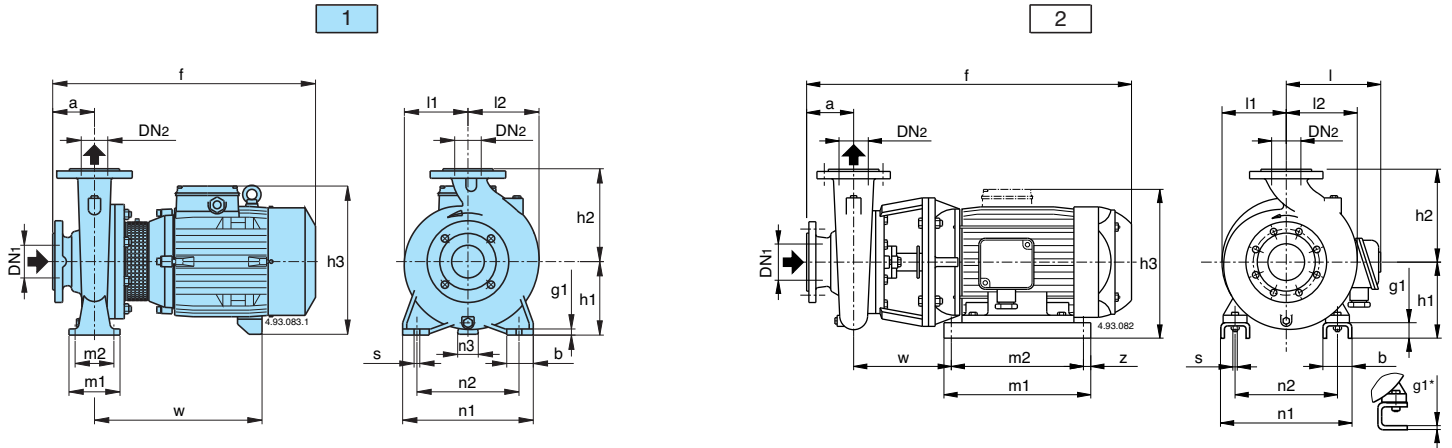

| Picture | NM | mm | | | | | | | | | | | | | | | | | | | kg | |
|-------------------|---------------------|-----|-----|------|-----|-----|-------|-----|-----|-----|-----|-----|----|----|----|-----|-----|-----|-----|-------------|----------|-------------|
| | | DN1 | DN2 | a | f | h1 | h2 | h3 | m1 | m2 | n1 | n2 | n3 | z | b | s | l | l1 | l2 | w | g1 | |
| 1 | NM 32/12SE-AE-DE-FE | 50 | 32 | 80 | 405 | 112 | 140 | 240 | 100 | 70 | 190 | 140 | 37 | - | 50 | 14 | - | 93 | 97 | 245 | 12 | 27-25-24-24 |
| | NM 32/16AE-BE | 50 | 32 | 80 | 410 | 132 | 160 | 260 | 100 | 70 | 240 | 190 | 47 | - | 50 | 14 | - | 120 | 120 | 250 | 12 | 36-34 |
| | NM 32/20DE | 50 | 32 | 80 | 410 | 160 | 180 | 288 | 100 | 70 | 240 | 190 | 62 | - | 50 | 14 | - | 140 | 140 | 250 | 39 | |
| | NM 32/20CE | | | | 295 | | | | | | | | | | | | | | | 49 | | |
| | NM 32/20AE | | | | 295 | | | | | | | | | | | | | | | 52 | | |
| | NM 40/12A/A-C/A-F/A | 65 | 40 | 80 | 410 | 112 | 140 | 240 | 100 | 70 | 210 | 160 | 37 | - | 50 | 14 | - | 100 | 113 | 250 | 12 | 31-29-27 |
| | NM 40/16C/A | 65 | 40 | 80 | 410 | 132 | 160 | 260 | 100 | 70 | 240 | 190 | 47 | - | 50 | 14 | - | 119 | 119 | 250 | 36 | |
| | NM 40/16B/A | | | | 295 | | | | | | | | | | | | | | | 45 | | |
| | NM 40/16A/A | | | | 295 | | | | | | | | | | | | | | | 49 | | |
| | NM 40/20CE-DE | 65 | 40 | 100 | 495 | 160 | 180 | 288 | 100 | 70 | 265 | 212 | 60 | - | 50 | 14 | - | 140 | 140 | 295 | 55-55 | |
| | NM 40/20AE-ARE-BE | | | | 320 | | | 49 | | | | | | | | | | | | 320 | 72-65-65 | |
| | NM 40/25B/A-C/A | 65 | 40 | 100 | 640 | 180 | 225 | 365 | 125 | 95 | 320 | 250 | 50 | - | 65 | 14 | - | 175 | 175 | 410 | 116-110 | |
| | NM 40/25A/A | | | | 690 | | | | | | | | | | | | | | | 15 | 460 | 133 |
| | NM 50/12F/A | 65 | 50 | 100 | 430 | 132 | 160 | 260 | 100 | 70 | 240 | 190 | 47 | - | 50 | 14 | - | 121 | 137 | 250 | 38 | |
| | NM 50/12D/A | | | | 495 | | | | | | | | | | | | | | | 45 | 295 | 47 |
| NM 50/12A/A-S/A | 495 | | | | 45 | | | | | | | | | | | | | | | 295 | 51-51 | |
| NM 50/16A/A-B/A | 65 | 50 | 100 | 525 | 160 | 180 | 320 | 100 | 70 | 265 | 212 | 49 | - | 50 | 14 | - | 127 | 141 | 320 | 14 | 70-64 | |
| NM 50/20A/A-B/A | 65 | 50 | 100 | 640 | 160 | 200 | 345 | 100 | 70 | 265 | 212 | 40 | - | 50 | 14 | - | 140 | 153 | 410 | 106-100 | | |
| NM 50/20S/A | | | | 695 | | | | | | | | | | | | | | | 15 | 460 | 112 | |
| NM 50/25C/A | 65 | 50 | 100 | 645 | 180 | 225 | 365 | 125 | 95 | 320 | 250 | 50 | - | 65 | 14 | - | 175 | 175 | 415 | 126 | | |
| NM 50/25B/A | | | | 695 | | | | | | | | | | | | | | | 15 | 465 | 132 | |
| NM 50/25A/A | | | | 720 | | | | | | | | | | | | | | | 15 | 465 | 147 | |
| NM 50M/EE | 65 | 50 | 100 | 700 | 192 | 225 | 377 | 298 | 258 | 262 | 216 | - | 20 | 69 | 12 | - | 175 | 175 | 239 | 135 | | |
| NM 50M/DE | | | | 750 | | | | | | | | | | | | | | | 151 | | | |
| NM 50M/CE | | | | 775 | | | | | | | | | | | | | | | 165 | | | |
| NM 65/12EE | 80 | 65 | 100 | 495 | 160 | 180 | 288 | 125 | 95 | 280 | 212 | 60 | - | 65 | 14 | - | 134 | 156 | 295 | 55 | | |
| NM 65/12AE-CE | | | | 320 | | | 73-67 | | | | | | | | | | | | | | | |
| NM 65/16DE-EE | 80 | 65 | 100 | 525 | 160 | 200 | 320 | 125 | 95 | 280 | 212 | 49 | - | 65 | 14 | - | 150 | 172 | 320 | 75-70 | | |
| NM 65/16BE-CE | | | | 640 | | | 15 | | | | | | | | | | | | 410 | 106-100 | | |
| NM 65/16AE | | | | 690 | | | 15 | | | | | | | | | | | | 460 | 121 | | |
| NM 65/20CE | 80 | 65 | 100 | 690 | 180 | 225 | 365 | 125 | 95 | 320 | 250 | 50 | - | 65 | 14 | - | 155 | 175 | 460 | 127 | | |
| NM 65/20BE | | | | 715 | | | | | | | | | | | | | | | 15 | 460 | 139 | |
| NM 65/200AE | 80 | 65 | 100 | 825 | 202 | 225 | 408 | 400 | 360 | 344 | 254 | - | 20 | 90 | 14 | - | 155 | 175 | 245 | 42 | 164 | |
| NM 65/250BE-CE | 80 | 65 | 100 | 825 | 202 | 250 | 408 | 400 | 360 | 344 | 254 | - | 20 | 90 | 14 | - | 175 | 190 | 245 | 195-174 | | |
| NM 65/250AE | | | | 945 | | | 45 | | | | | | | | | | | | 263 | 299 | | |
| NM 80/16EE | 100 | 80 | 125 | 545 | 180 | 225 | 340 | 125 | 95 | 320 | 250 | 60 | - | 65 | 14 | - | 165 | 193 | 320 | 83 | | |
| NM 80/16CE-DE | | | | 670 | | | 15 | | | | | | | | | | | | 415 | 113-108 | | |
| NM 80/16BE | | | | 720 | | | 15 | | | | | | | | | | | | 465 | 130 | | |
| NM 80/16AE | | | | 745 | | | 15 | | | | | | | | | | | | 465 | 144 | | |
| NM 80/200AE-BE | 100 | 80 | 125 | 850 | 202 | 250 | 408 | 400 | 360 | 344 | 254 | - | 20 | 90 | 14 | - | 170 | 194 | 245 | 42 | 194-173 | |
| NM 80/250DE-EE | 100 | 80 | 125 | 850 | 202 | 280 | 408 | 400 | 360 | 344 | 254 | - | 20 | 90 | 14 | - | 191 | 210 | 245 | 203-182 | | |
| NM 80/250AE-BE-CE | | | | 970 | | | 45 | | | | | | | | | | | | 263 | 377-361-331 | | |
| NM 100/200EE | | | | 800 | | | 192 | | | | | | | | | | | | 377 | 298 | 258 | 262 |
| NM 100/200CE-DE | 125 | 100 | 125 | 850 | 202 | 280 | 408 | 400 | 360 | 344 | 254 | - | 20 | 90 | 14 | - | 180 | 212 | 245 | 195-174 | | |
| NM 100/200AE-BE | | | | 970 | | | 45 | | | | | | | | | | | | 263 | 355-323 | | |
| NM 100/250BE | 125 | 100 | 140 | 980 | 245 | 280 | - | 475 | 425 | 408 | 318 | - | 25 | 90 | 18 | 290 | 205 | 233 | 263 | 386 | | |
| NM 100/250AE | | | | 1050 | | | 50 | | | | | | | | | | | | 305 | 498 | | |

Flanges
EN 1092-2

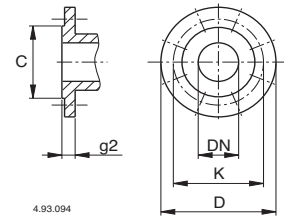

| mm | | | | | |
|-----|-----|-----|-----|-----------------|----|
| DN | C | K | D | Holes N° Ø | g2 |
| 32 | 76 | 100 | 140 | 4 19 | 18 |
| 40 | 84 | 110 | 150 | 4 19 | 18 |
| 50 | 99 | 125 | 165 | 4 19 | 20 |
| 65 | 118 | 145 | 185 | 4 19 | 20 |
| 80 | 132 | 160 | 200 | 8 19 | 22 |
| 100 | 156 | 180 | 220 | 8 19 | 24 |
| 125 | 184 | 210 | 250 | 8 19 | 24 |

Dimensions and weights

2

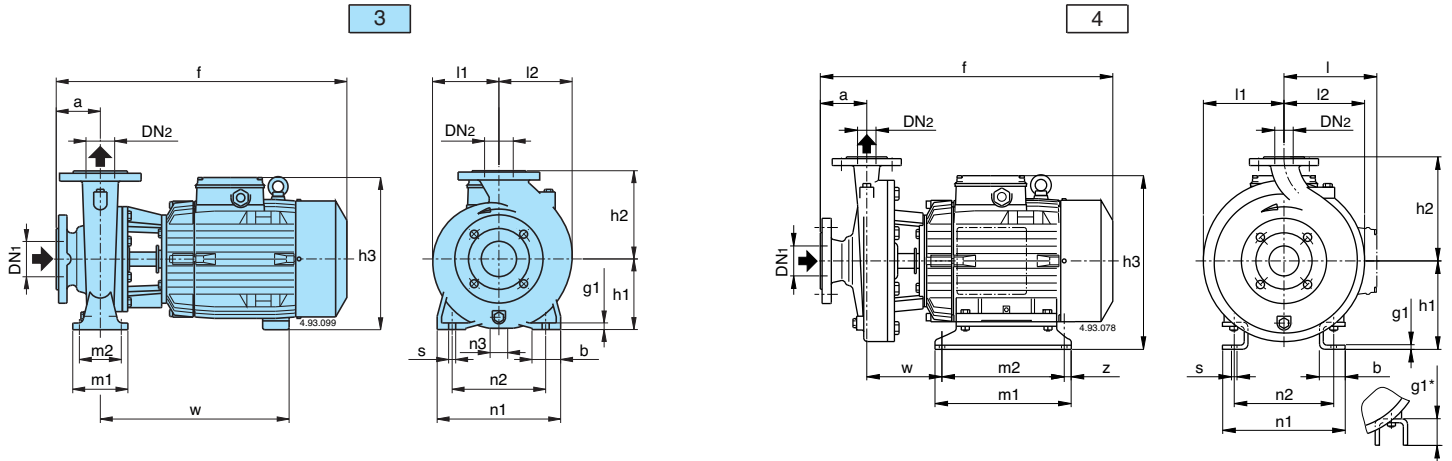

| Picture | B- NM | mm | | | | | | | | | | | | | | | | | | | kg | | |
|---------|--|-----|-----|-----|-------------------|-------------------|-----|-------------------|-------------------|-------------------|-------------------|-------------------|----------------|----------|----------------|----------------|---|-----|-----|-------------------|---------------|-------------------|----------------|
| | | DN1 | DN2 | a | f | h1 | h2 | h3 | m1 | m2 | n1 | n2 | n3 | z | b | s | l | l1 | l2 | w | g1 | B-NM | |
| 1 | B-NM 32/12S-A B-NM 32/12D-F | 50 | 32 | 80 | 405 | 112 | 140 | 240 | 100 | 70 | 190 | 140 | 37 | - | 50 | 14 | - | 93 | 97 | 245 | 12 | 33-32 31-29 | |
| | B-NM 32/16B B-NM 32/16A | 50 | 32 | 80 | 410 410 | 132 | 160 | 260 | 100 | 70 | 240 | 190 | 47 | - | 50 | 14 | - | 120 | 120 | 250 250 | 12 | 44 45 | |
| | B-NM 32/20D B-NM 32/20C B-NM 32/20A | 50 | 32 | 80 | 410 475 475 | 160 | 180 | 288 | 100 | 70 | 240 | 190 | 45 60 60 | - | 50 | 14 | - | 140 | 140 | 250 295 295 | 12 | 49 57 61 | |
| | B-NM 40/12F B-NM 40/12A-C | 65 | 40 | 80 | 410 410 | 112 | 140 | 240 | 100 | 70 | 210 | 160 | 37 | - | 50 | 14 | - | 100 | 113 | 250 250 | 12 | 33 37-35 | |
| | B-NM 40/16C B-NM 40/16B B-NM 40/16A | 65 | 40 | 80 | 410 475 475 | 132 | 160 | 260 | 100 | 70 | 240 | 190 | 47 45 45 | - | 50 | 14 | - | 119 | 119 | 250 295 295 | 12 | 45 53 57 | |
| | B-NM 40/20C-D B-NM 40/20AE-BE | 65 | 40 | 100 | 495 580 | 160 | 180 | 288 320 | 100 | 70 | 265 | 212 | 60 49 | - | 50 | 14 | - | 140 | 140 | 295 375 | 12 | 63-62 80-74 | |
| | B-NM 4025/B/A-C/A B-NM 4025/A/A | 65 | 40 | 100 | 635 685 | 192 | 225 | 377 | 298 | 258 | 262 | 216 | - | 20 | 69 | 12 | - | 175 | 175 | 174 | 6 | 130-124 147 | |
| 1 | B-NM 50/12F B-NM 50/12D B-NM 50/12A-S | 65 | 50 | 100 | 430 495 495 | 132 | 160 | 260 | 100 | 70 | 240 | 190 | 47 45 45 | - | 50 | 14 | - | 121 | 137 | 250 295 295 | 12 | 49 58 63-63 | |
| | B-NM 50/160A/A-B/A | 65 | 50 | 100 | 580 | 160 | 180 | 320 | 100 | 70 | 265 | 212 | 49 | - | 50 | 14 | - | 127 | 141 | 375 | 14 | 80-74 | |
| | B-NM 50/200S/A-A/A-B/A | 65 | 50 | 100 | 695 | 192 | 200 | 377 | 298 | 258 | 262 | 216 | - | 20 | 69 | 12 | - | 140 | 153 | 234 | 6 | 128-121 | |
| 4 | B-NM 5025/C/A B-NM 5025/B/A B-NM 5025/A/A | 65 | 50 | 100 | 635 685 710 | 192 | 225 | 377 | 298 | 258 | 262 | 216 | - | 20 | 69 | 12 | - | 175 | 175 | 174 | 6 | 135 144 155 | |
| | B-NM 5025/65EE B-NM 5025/65DE B-NM 5025/65CE | 65 | 50 | 100 | 635 685 710 | 192 | 225 | 377 | 298 | 258 | 262 | 216 | - | 20 | 69 | 12 | - | 175 | 175 | 174 | 6 | 135 144 155 | |
| | B-NM 65/125AE-CE | 80 | 65 | 100 | 580 | 160 | 180 | 320 | 125 | 95 | 280 | 212 | 49 | - | 65 | 14 | - | 134 | 156 | 375 | 15 | 93-72 | |
| | B-NM 65/160DE-EE B-NM 65/160CE | 80 | 65 | 100 | 575 660 | 160 | 200 | 320 345 | 125 | 95 | 280 | 212 | 49 40 | - | 65 | 14 | - | 150 | 172 | 375 430 | 15 | 83-78 108 | |
| 4 | B-NM 65/160BE B-NM 65/160AE | 80 | 65 | 100 | 695 745 | 192 | 200 | 377 | 298 | 258 | 262 | 216 | - | 20 | 69 | 12 | - | 150 | 172 | 234 | 6 | 149 166 | |
| | B-NM 65/200CE B-NM 65/200BE B-NM 65/200AE | 80 | 65 | 100 | 750 775 825 | 192 192 202 | 225 | 377 377 408 | 298 258 400 | 258 262 360 | 262 216 344 | 216 216 254 | - | 20 | 69 69 90 | 12 12 14 | - | 155 | 175 | 239 239 245 | 6 6 42* | 157 177 179 | |
| | B-NM 65/250BE-CE B-NM 65/250AE | 80 | 65 | 100 | 825 945 | 202 245 | 250 | 408 475 | 400 425 | 360 408 | 344 408 | 254 318 | - | 20 25 | 90 90 | 14 18 | - | 290 | 175 | 190 | 245 263 | 42* 45* | 210-189 350 |
| | B-NM 80/160EE B-NM 80/160DE | 100 | 80 | 125 | 605 685 | 180 | 225 | 340 365 | 125 | 95 | 320 | 250 | 60 50 | - | 65 | 14 | - | 165 | 193 | 375 430 | 15 | 108 116 | |
| | B-NM 80/160CE B-NM 80/160BE B-NM 80/160AE | 100 | 80 | 125 | 725 775 800 | 192 | 225 | 377 | 298 | 258 | 262 | 216 | - | 20 | 69 | 12 | - | 165 | 193 | 239 | 6 | 155 163 166 | |

Flanges
EN 1092-2

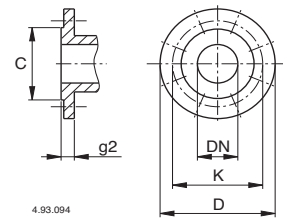

| mm | | | | | | |
|-----|-----|-----|-----|-------|----|----|
| DN | C | K | D | Holes | | g2 |
| | | | | N° | Ø | |
| 32 | 76 | 100 | 140 | 4 | 19 | 18 |
| 40 | 84 | 110 | 150 | 4 | 19 | 18 |
| 50 | 99 | 125 | 165 | 4 | 19 | 20 |
| 65 | 118 | 145 | 185 | 4 | 19 | 20 |
| 80 | 132 | 160 | 200 | 8 | 19 | 22 |
| 100 | 156 | 180 | 220 | 8 | 19 | 24 |
| 125 | 184 | 210 | 250 | 8 | 19 | 24 |