

IT Istruzioni per l'installazione  
GB Installation Instructions  
FR Instructions d'installation  
DE Montage-Anweisungen  
ES Instrucciones de instalación  
PT Instruções de instalação  
NL Instructies voor het installeren.  
PL Instrukcja instalacji  
CZ Montážní návod  
SK Montážny návod  
SI Navodila za montažo  
SE Instruktioner för installationen  
DK Installationsvejledning  
NO Instruks for installasjon  
FI Asennus ohjeet  
GR ΟΔΗΓΙΕΣ ΕΓΚΑΤΑΣΤΑΣΗΣ  
BG Инструкции за експлоатация  
EE Paigaldusjuhend  
LV Ierikošanas instrukcija  
LT Montavimo instrukcija  
RO Instrucțiuni de instalare  
HU Összeszerelési útmutató  
RU Инструкция по монтажу  
CN 安裝指引  
AE التركيب تعليمات  
IS Leiðbeiningar v/uppsetningu  
TR Montaj bilgisidir

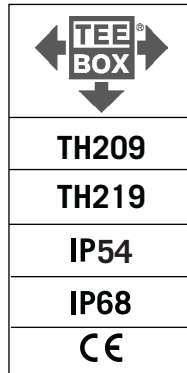

NO Koble fra Hovedstrømkilden før montering. Er en i tvil, kontakt kvalifisert elektriker  
FI Eristä Päävirtalähde ennen yhdistämistä. Jos epäilet, kysy ammattisähkömieheltä  
GR ΚΛΕΙΣΤΕ ΤΗΝ ΠΑΡΟΧΗ ΤΟΥ ΡΕΥΜΑΤΟΣ ΠΡΙΝ ΞΕΚΙΝΗΣΕΤΕ ΑΝ ΕΧΕΤΕ ΑΜΦΙΒΟΛΙΕΣ ΣΥΜΒΟΥΛΕΥΤΕΙΤΕ ΗΛΕΚΤΡΟΛΟΓΟ  
BG Прекъснете захранващото напрежение преди започване. Ако не сте сигурни, консултирайте се с квалифициран електротехник  
EE Lülitage vooluallikas enne alustamist välja. Kahtluse puhul konsulteerige kvalifitseeritud elektrikuga  
LV Noizolēt Galveno Spēka pievadu pirms darbu uzsākšanas. Ja neesat pārliecināti, par veicamā pareizību, konsultējaties ar profesionālu elektrīķi!  
LT Prieš pradėdami atjunkite maitinimo šaltinį. Jei abejojate-pasitarkite su kvalifikuotu elektriku  
RO Înainte de conectarea la rețea opriți curentul, dacă aveți dificultăți cu instalarea apelați un electrician autorizat  
HU Áramtalanítsa a készüléket mielőtt hozzáféksz. Ha kérdése van forduljon képzett szakemberhez  
RU Перед началом монтажа стоит отключить токоподачу. В случае сомнений прошу снестись с квалифицированным электриком  
CN 安裝及測試前請先關掉電源。如有疑問，請諮詢合資格電器工程師。  
AE تأكد من فصل مزود الطاقة الرئيسي قبل التركيب. وإن كانت لديك أية شكوك، يرجى الاستعانة بخبير كهرباء اخصائي.  
IS EINANGRÍÐ - VEIT ER EKKI HVAÐ HANN ER AÐ REYNA AÐ SEGJA HÉRNA EF EITTHVAÐ ER ÓLJÓST, HAFIÐ ÞÁ SAMBAND VIÐ RAFVIRKJA  
TR ANA ENERJİ KAYNAGINI BASLAMADAN ÖNCE İZOLE EDİN.SUPHE ANINDA LUTFEN KALIFIYE BİR ELEKTRİKÇİYE DANISIN

IT Grazie per aver acquistato un prodotto "MADE IN ITALY"  
GB Thank you for having purchased a "MADE IN ITALY" product  
FR Merci pour avoir acheté un produit "MADE IN ITALY"  
DE Vielen Dank, dass Sie ein Produkt, "MADE IN ITALY" gekauft haben  
ES Gracias por comprar un producto "MADE IN ITALY"  
PT Os nossos agradecimentos por preferir um produto de "MADE IN ITALY"  
NL Wij danken u voor uw aankoop van een product "MADE IN ITALY"  
PL Serdecznie podziękowania za zakup produktu "MADE IN ITALY"  
CZ Děkujeme Vám za zakoupení "MADE IN ITALY" výrobku.  
SL Āakujemo Vām za zakūpenie "MADE IN ITALY" výrobku.  
SI Zahvaljujemo se vam za nakup izdelka "MADE IN ITALY"  
SE Tack för att du köpt en "MADE IN ITALY" produkt  
DK Tak for Deres køb af et "MADE IN ITALY" produkt.  
NO Takk for at du har kjøpt et "MADE IN ITALY" produkt.  
FI Kiitos että ostitte "MADE IN ITALY" tuotteen.  
GR ΕΥΧΑΡΙΣΤΟΥΜΕ ΠΟΥ ΑΓΟΡΑΣΑΤΕ ΠΡΟΪΟΝ ΚΑΤΑΣΚΕΥΑΣΜΕΝΟ "MADE IN ITALY"  
BG Благодарим Ви, че закупихте "MADE IN ITALY" продукт.  
EE Täname, et ostsite "MADE IN ITALY" toote.  
LV Paldies, ka izvēlējāties pirkumu, kas "MADE IN ITALY"  
LT Ačiū, kad įsigijote produktą pagaminatą "MADE IN ITALY"  
RO Va multumim ca a-ti ales produsul nostru "MADE IN ITALY"  
HU Köszönjük, hogy "MADE IN ITALY" terméket választott  
RU Благодарим за покупку продукта "MADE IN ITALY"  
CN 多謝購買本公司"MADE IN ITALY"之產品  
AE ايطالي في صنع  
IS TAKK FYRIR AÐ HAFI KEYPPT VÖRUR "MADE IN ITALY"  
TR "MADE IN ITALY" MENSEGLİ URUNU TERCIH ETTİGİNİZ İCİN TESEKURLER.



IT Togliere corrente prima di iniziare. Se in dubbio consultare un elettricista qualificato.  
GB Isolate Mains Power supply before commencing. If in doubt, consult qualified electrician  
FR Couper l'alimentation principale avant de commencer. En cas de doute, consulter un electricien qualifié  
DE Vor Inbetriebnahme vom Stromnetz trennen. Wenn im Zweifel, Beratung durch einen qualifizierten Elektriker.  
ES Aislar fuente de alimentación principal antes de comenzar. En caso de duda, consultar electricista cualificado  
PT Cortar a alimentação de corrente antes de proceder à ligação. Em caso de dúvida consultar um técnico especializado.  
NL Zet de hoofdschakelaar van de energievoorziening uit voordat u begint. Als u hierover twijfels heeft, vraag dan hulp aan een gediplomeerde electriciën.  
PL Odłączyć zasilanie przed rozpoczęciem instalacji. W przypadku wątpliwości proszę skonsultować się z wykwalifikowanym elektrykiem.  
CZ Před zahájením instalace odpojte hlavní přívod elektrické energie. V případě pochybností to konzultujte s kvalifikovanou osobou (elektrikářem).  
SL Pred zahájenim inštalacije odpojte glavni privod elektrickej energije. V pripade pochybnosti to konzultujte s kvalifikovanou osobou (elektrikárom).  
SI Pred začetkom del izklopite glavni vir napajanja. V kolikor ste v dvomih, se posvetujte s kvalificiranim električarjem.  
SE Koppla bort nätspänningen innan inkoppling. Vid tveksamhet, anlita kvalificerad elektriker.  
DK Afbryd strømmen før installationen påbegyndes. I tvivlstilfælde kontakt autoriseret elektriker

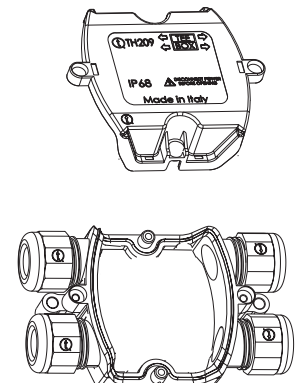
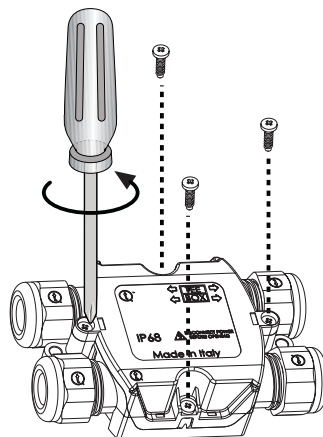
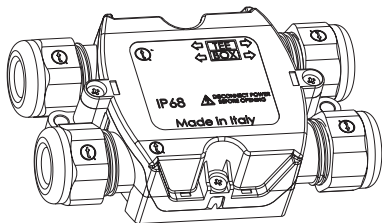

1

2

3

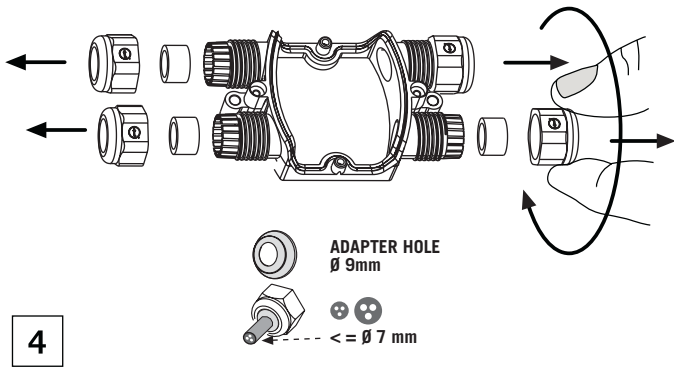

Cable Max Ø 14mm



Cable Max Ø 9,5mm

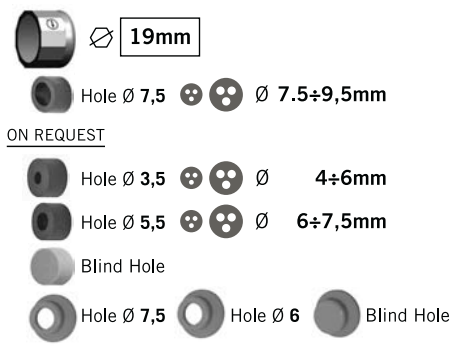

4

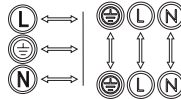
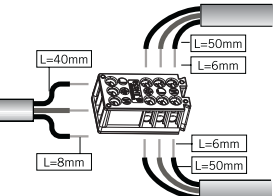
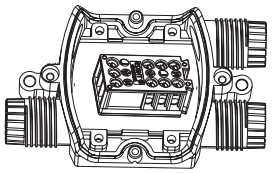
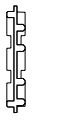
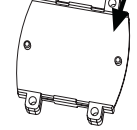
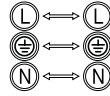
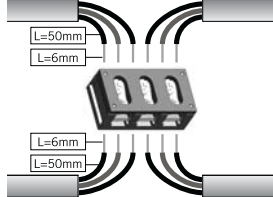
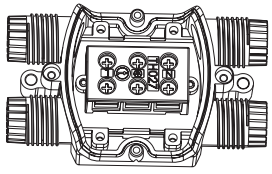
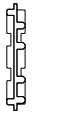
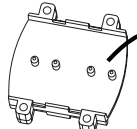
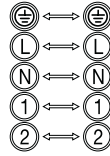
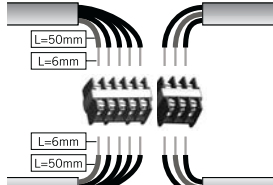
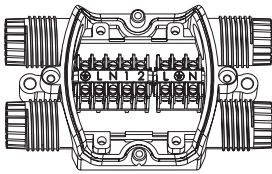
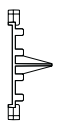
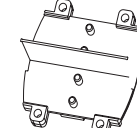
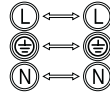
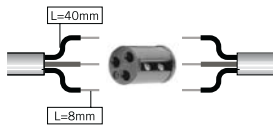
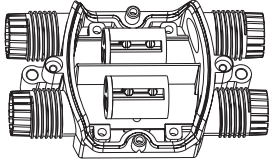
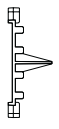
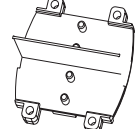
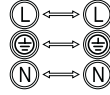
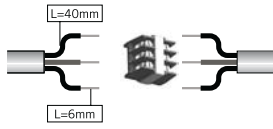
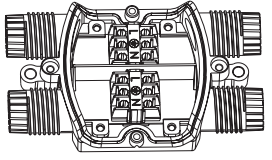

5

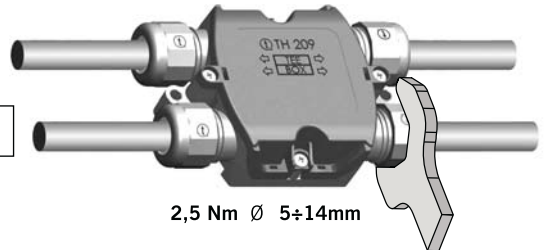
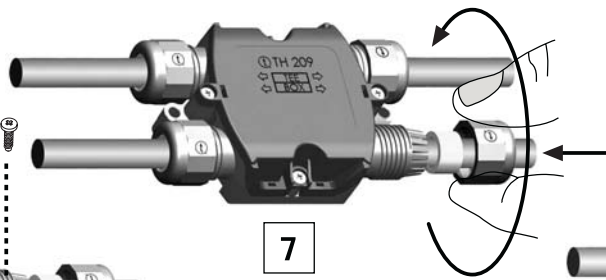
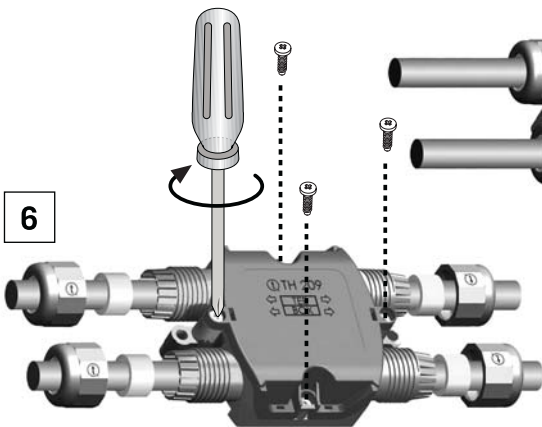

TH219

