

TECEdrainline – 6 0xx 01

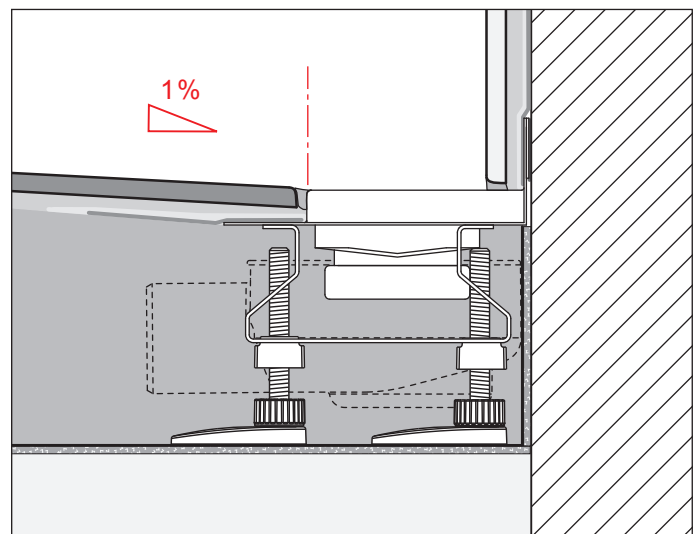

TECEdrainline – 6 0xx 01

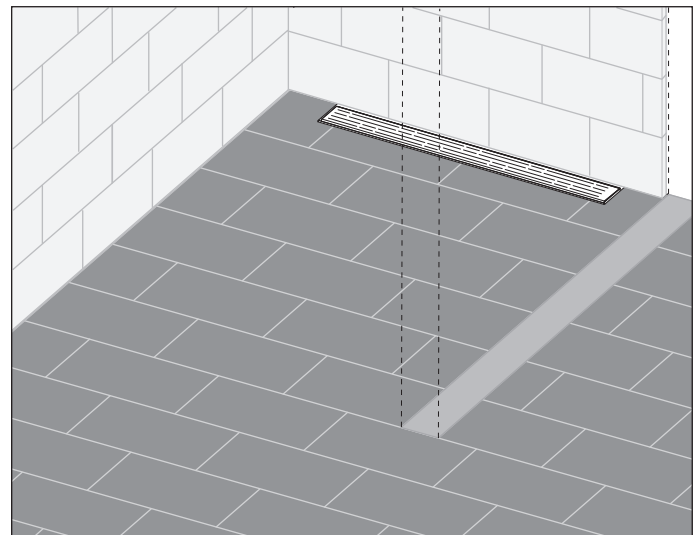
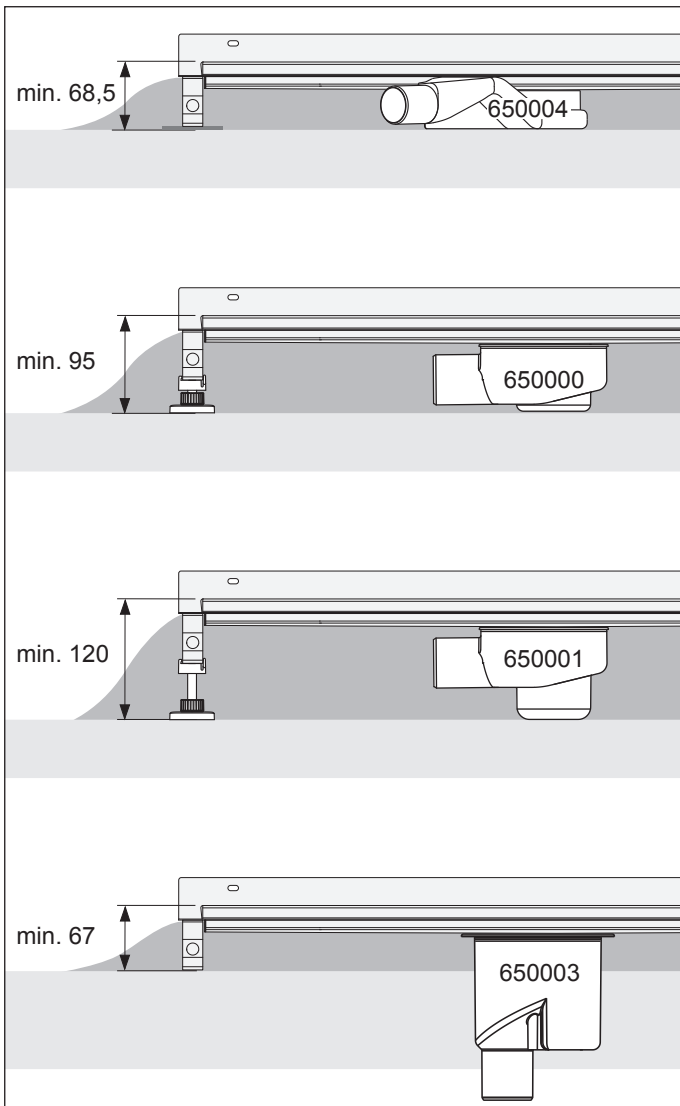
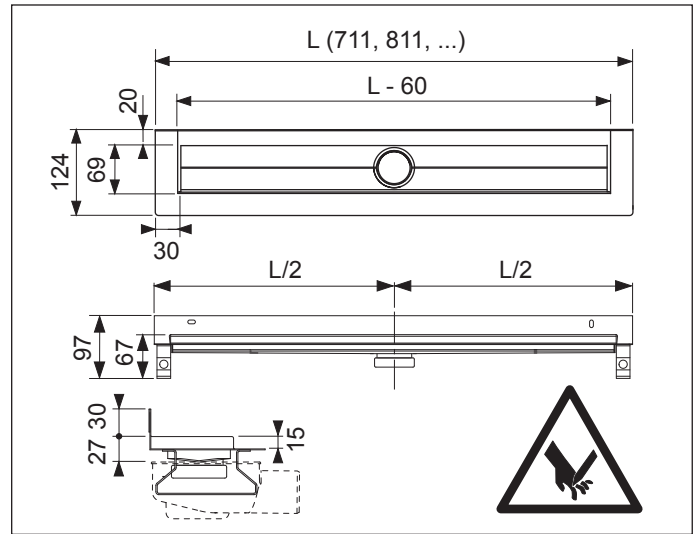
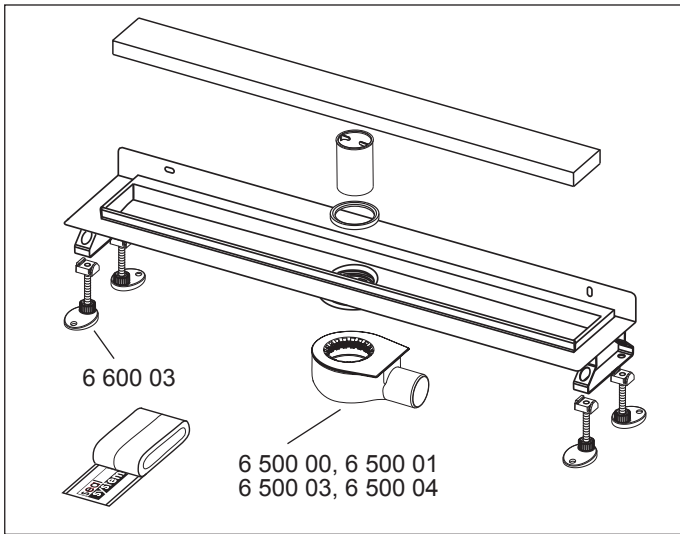
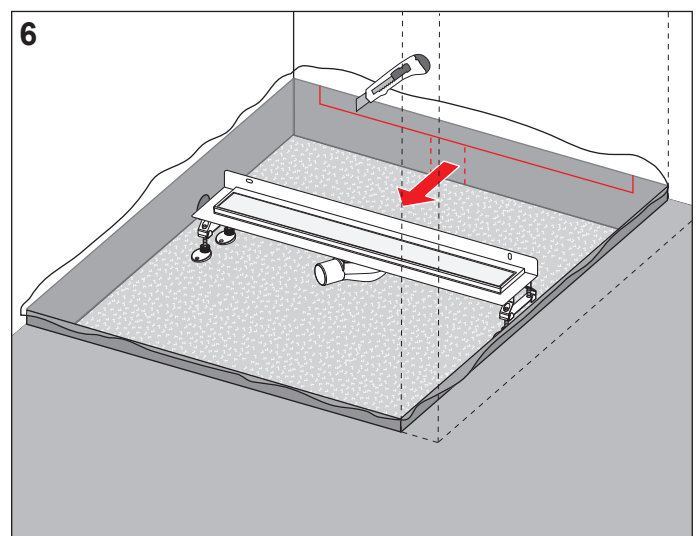
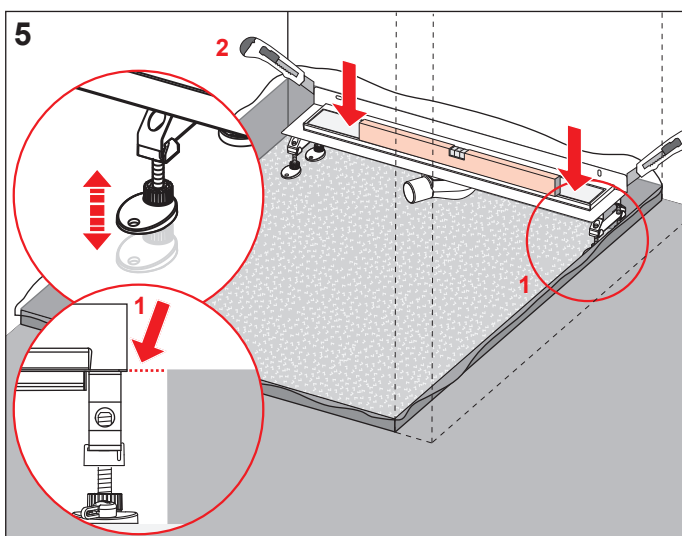
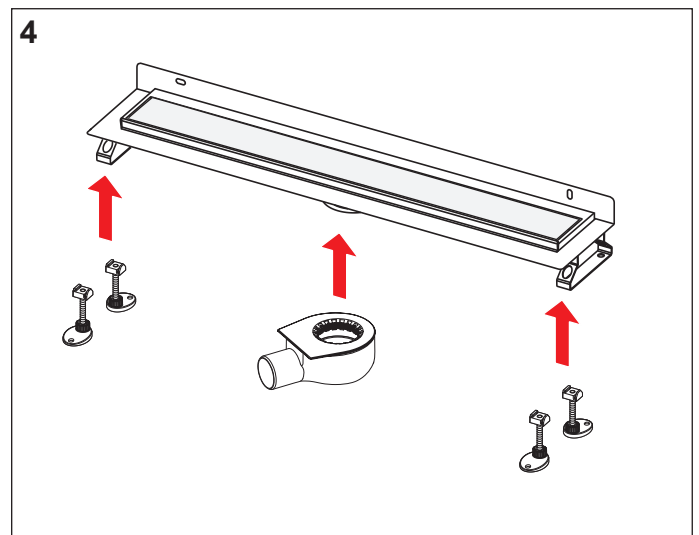
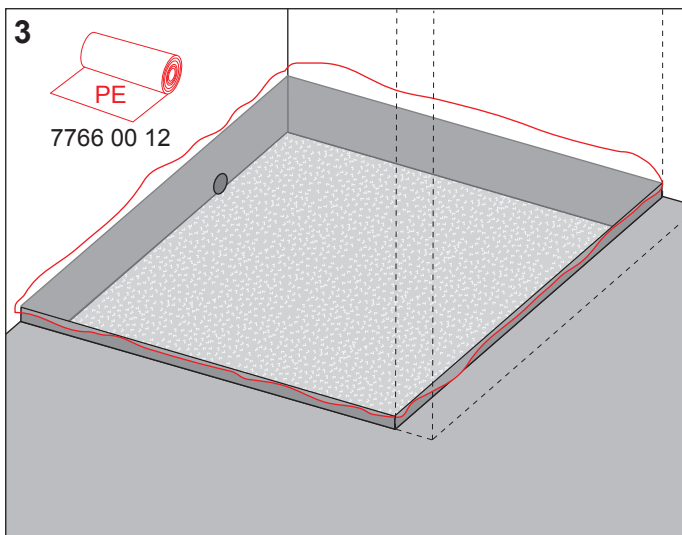
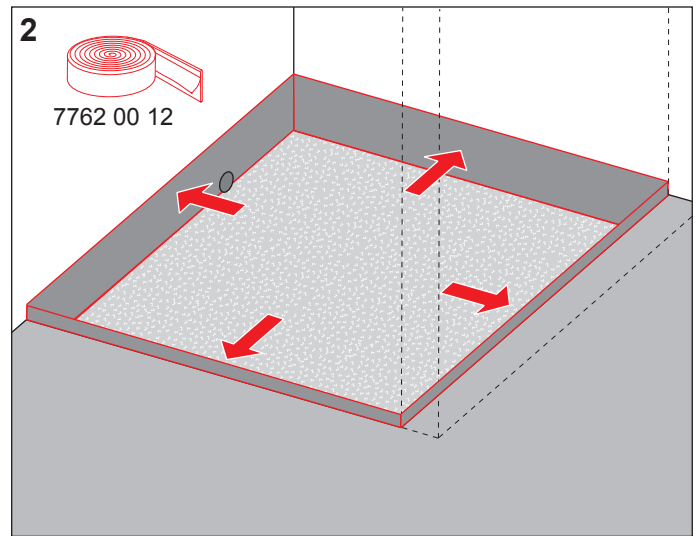
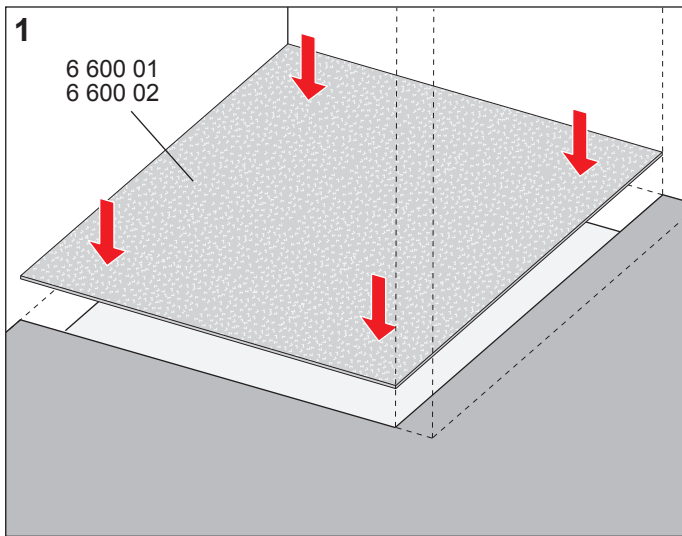

TECEdrainline – 6 0xx 01

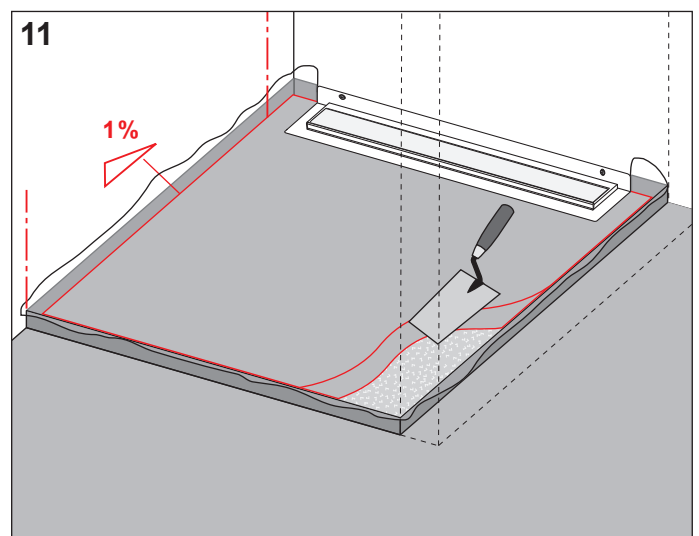
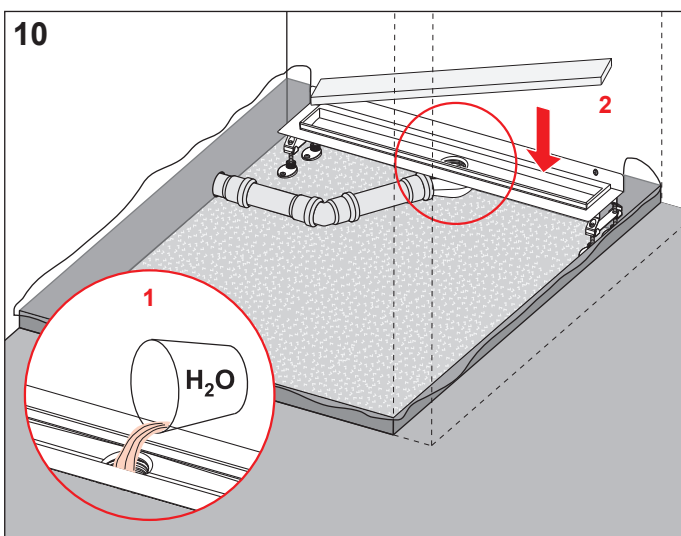
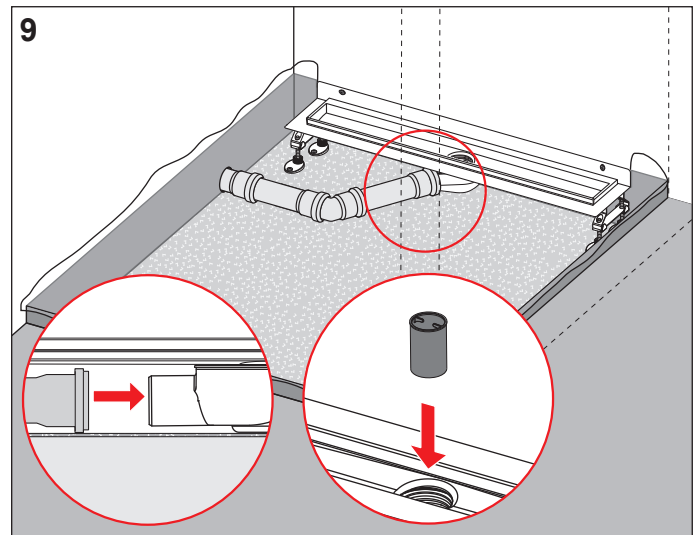
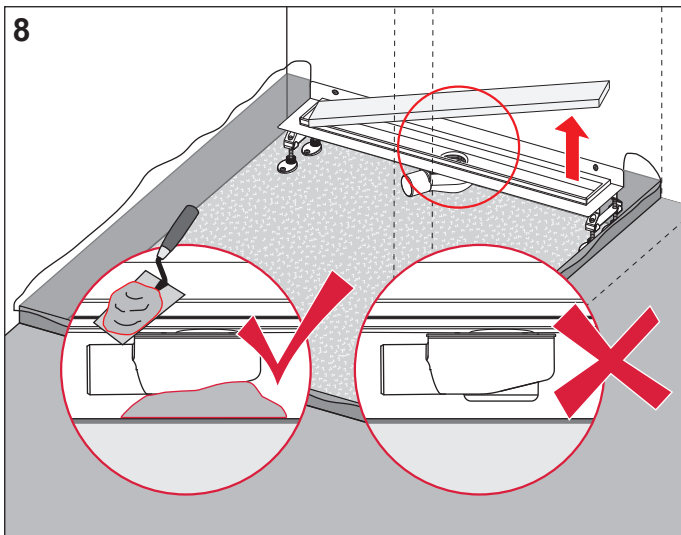
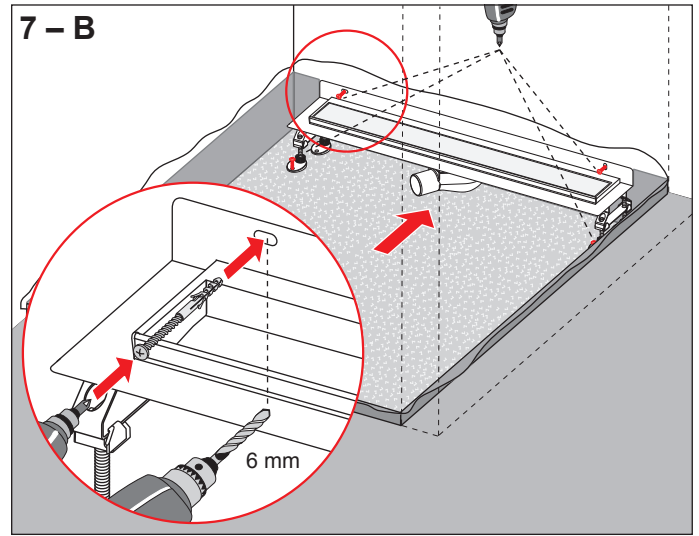
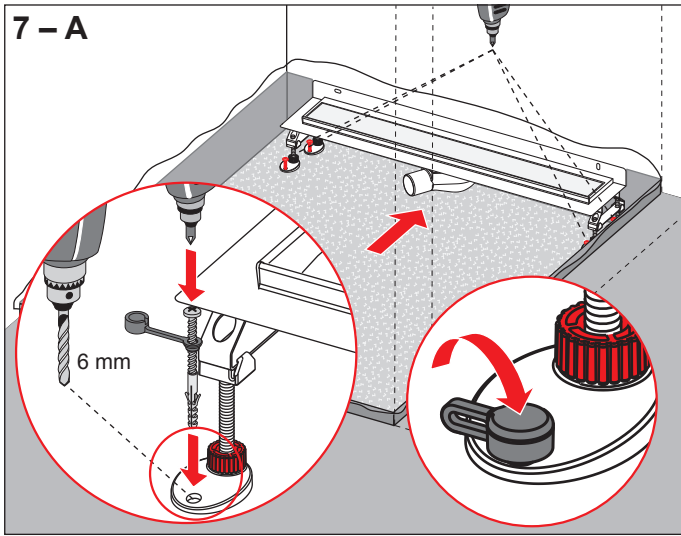

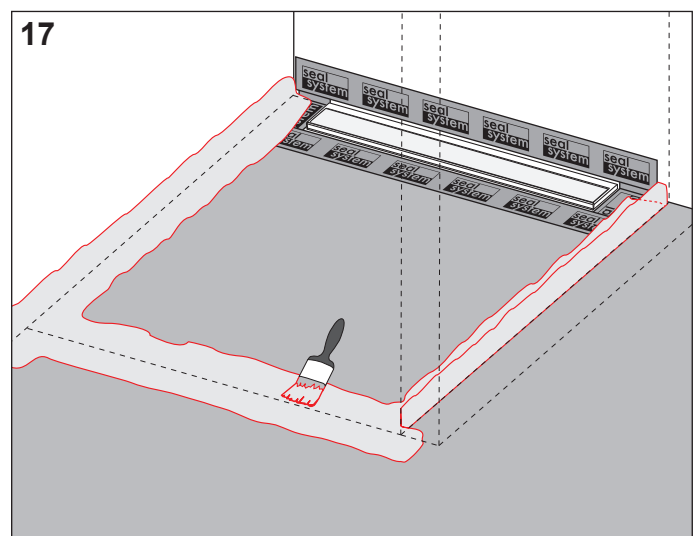
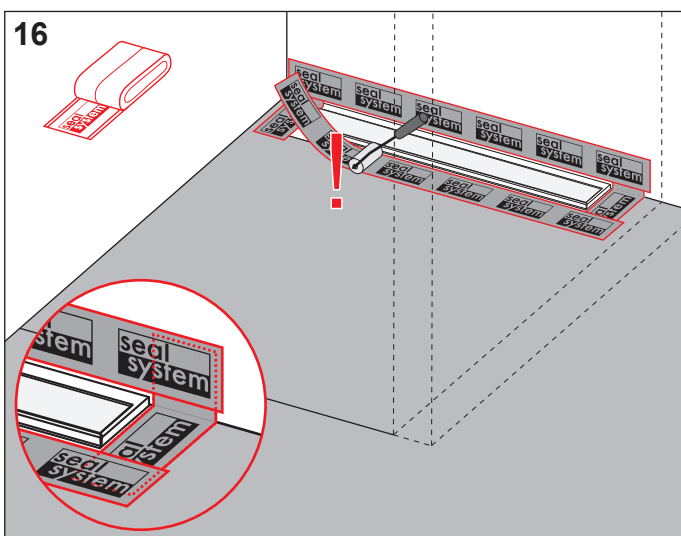
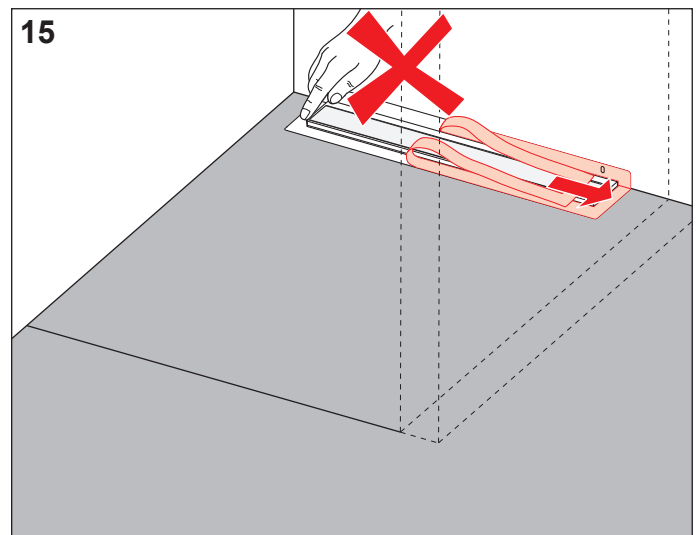
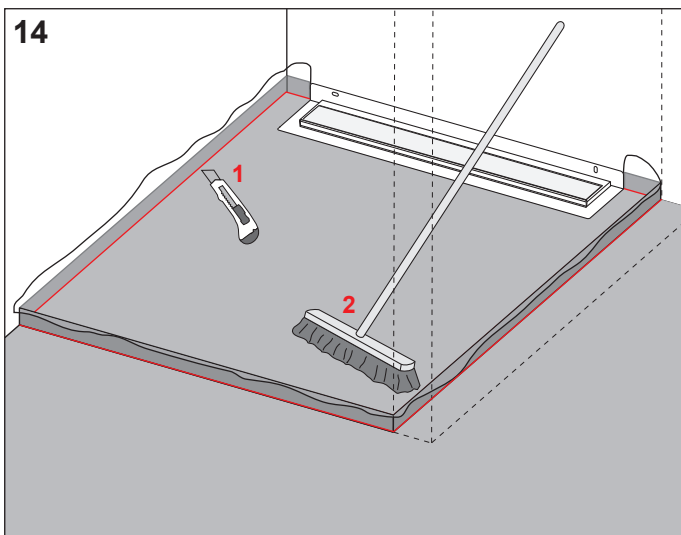
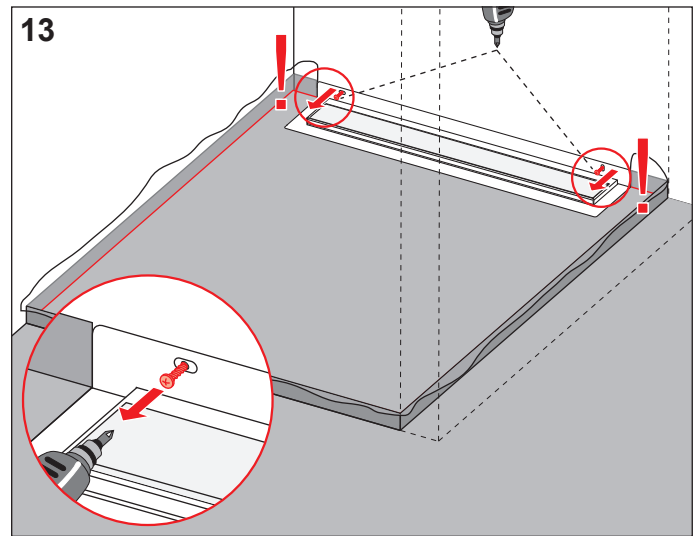
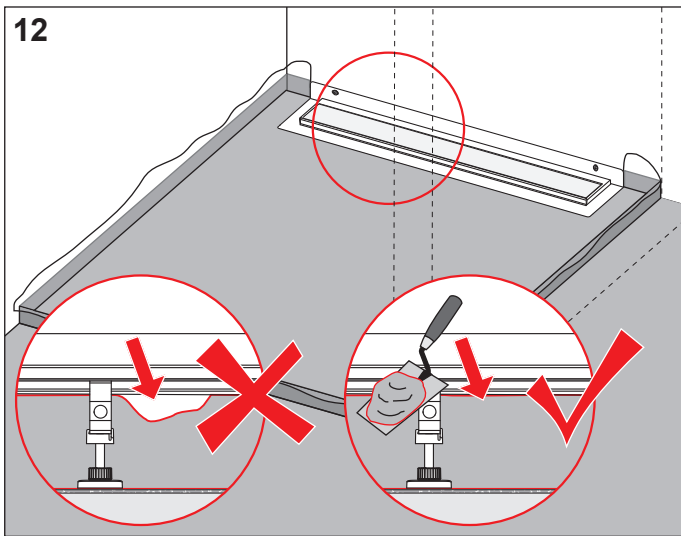

TECEdrainline – 6 0xx 01

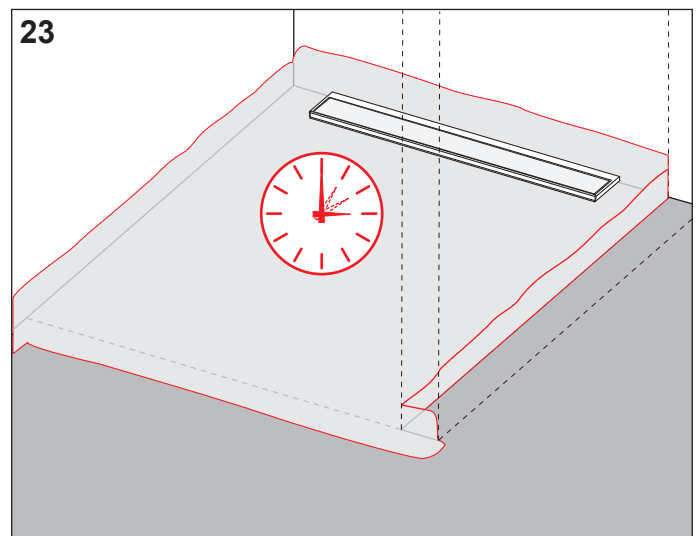
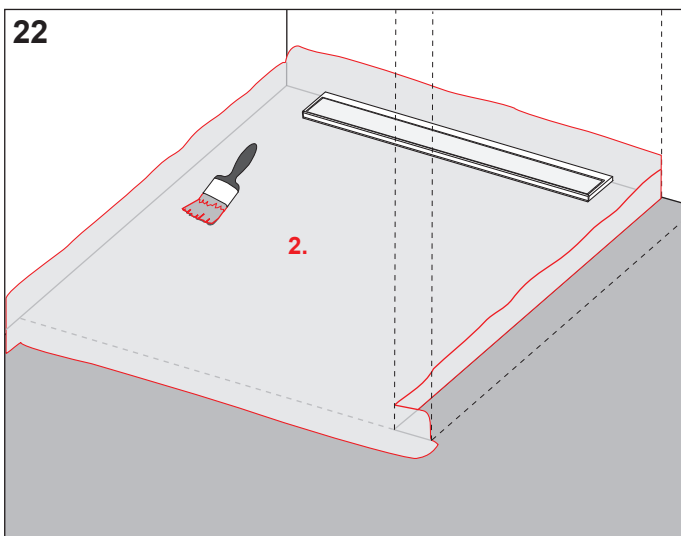
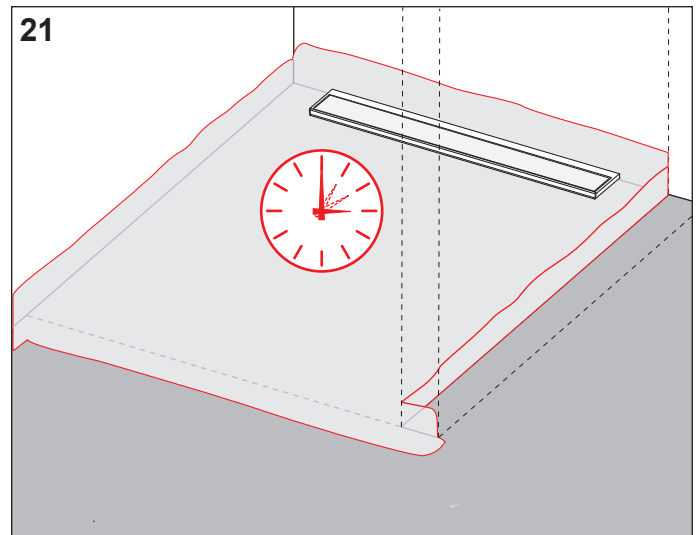
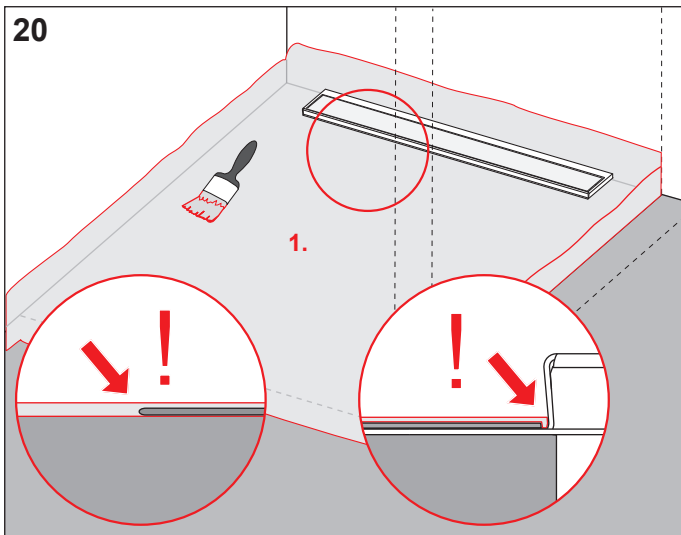
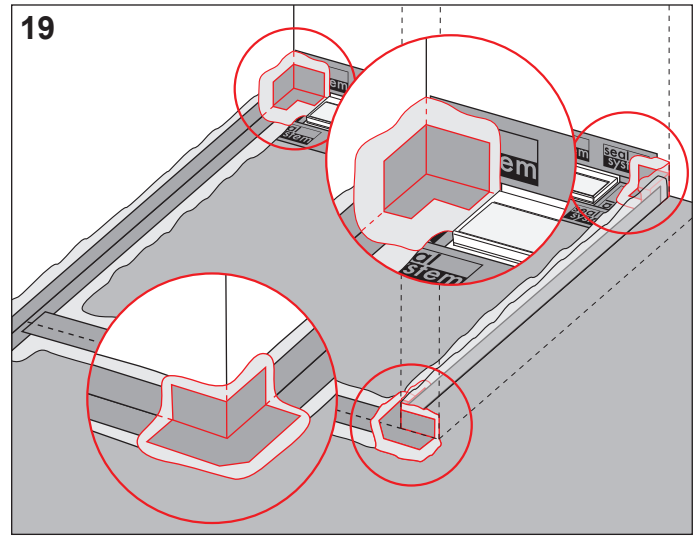
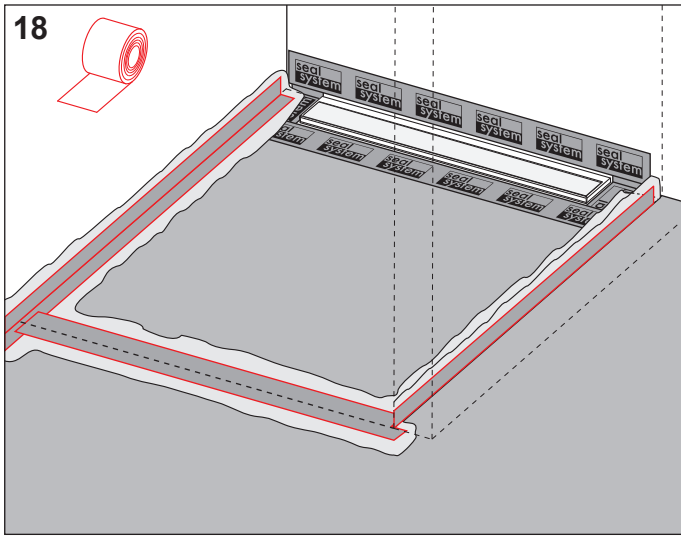

TECEdrainline – 6 0xx 01

