

Proven quality die stock with excellent threading capabilities.

Pipe threads	1/8" – 2", 16 – 50 mm
Bolt threads	6 – 30 mm, 1/4" – 1"

Thread types see page 30, 31.

**REMS eva – the plumber's die stock.**  
**Excellent start-cutting and threading.**  
**Steel ratchet lever, thickly plastic coated.**  
**Only one type of quick-change die heads.**  
**Indestructible quality dies.**

### System advantage

Large working range up to 1 1/4" and up to 2" with only **one** ratchet lever. Only **one** type of small, compact quick-change die heads and only **one** type of dies. The same quick-change die heads fit all REMS die stocks and other suitable makes of die stocks. Efficient and easy stocking. No confusion possible.

### Ratchet lever

Robust. Ratchet lever in steel, thickly plastic coated, for convenient operation. Serrated plastic handle for secure grip. Easy adjustment of ratchet rotation. Perfect, secure seating of quick-change die heads, fast and easy change.

### Quick-change die heads

Proven technology, high-grade material and precise machining of die head, dies and cover form a unit and ensure an excellent start-cutting performance and easy threading. No stalling of dies. Long, precise pipe guidance for perfect pipe centering. The chip holes which become wider at the outside enable good chip flow and clean threads. Quick-change die heads S for cutting pipe threads in hard-to-reach areas (page 23).

### Dies

The proven, indestructible REMS quality dies with precise cutting geometry ensure an excellent start-cutting performance, easy threading and clean threads. Dies in a high-quality special-grade steel, fully tempered and hardened, for extremely long die life.

### Thread-cutting oil

REMS Sanitol and REMS Spezial (page 49). Specially developed for threading. High cooling and lubricating effect. Essential for clean threads and longer service life of dies, tools and machines.

### Nipple-threading

Efficient with REMS Nippelspanner 3/8" – 2" (page 48).



German Quality Product



Info

### Supply format

**REMS eva Set.** Hand die stock with quick-change die heads. For pipe threads 1/8" – 2", 16 – 50 mm, bolt threads 6 – 30 mm, 1/4" – 1". For right and left-hand threads. 1 ratchet lever for the complete work range. Quick-change die heads with dies for pipe threads, tapered, ISO 7-1, EN 10226 (DIN 2999, BSPT) R right-hand respectively for threading electric conduit according to EN 60423 M. In sturdy steel case or in a cardboard box.

Description/Size	Art.-No.
<b>REMS eva Set in steel case</b>	
R 1/2 + 3/4 + 1	520014
R 1/2 + 3/4 + 1 + 1 1/4	520015
R 3/8 + 1/2 + 3/4 + 1 + 1 1/4	520013
R 1/2 + 3/4 + 1 + 1 1/4 + 1 1/2 + 2	520017
R 3/8 + 1/2 + 3/4 + 1 + 1 1/4 + 1 1/2 + 2	520016
M 16 + 20 + 25 + 32 (M x 1,5)	520010
M 20 + 25 + 32 + 40 (M x 1,5)	520009
<b>REMS eva Set in cardboard box</b>	
R 1/2 + 3/4	520008
R 1/2 + 3/4 + 1	520004
R 3/8 + 1/2 + 3/4 + 1 + 1 1/4	520003

REMS eva sets available for left-handed threads and NPT threads.

### Accessories

Description	Art.-No.
<b>Ratchet lever</b> for complete work range	522000
<b>Quick-change die heads S</b> see page 23.	
<b>Quick-change die heads, dies, attachment heads for button dies</b> , see page 30 – 31.	
<b>Steel case</b> with inlay, for REMS eva 3/8" – 2"	526050
<b>Thread-cutting oil</b> see page 49.	
<b>REMS Nippelspanner</b> 3/8" – 2" see page 48.	
<b>REMS Aquila 3B</b> , pipe workstation with chain pipe vice on folding tripod stand, see page 105.	
<b>REMS Aquila WB</b> , chain pipe vice for workbench, see page 105.	



# REMS quick-change die heads S

Accessories for REMS eva and other makes

For cutting pipe threads in hard-to-reach areas, e.g. caved wall, lay bare pipes, trench. Ideal for repair and renovation.

Pipe threads 3/8 – 1 1/4"

## REMS quick-change die heads S – the trouble shooter for hard-to-reach areas.

Quick-change die heads S with specially mounted dies.

Additional, precise pipe guidance at the cover side ensure perfect pipe centering and easy start-cutting.

Extension of ratchet drive REMS eva for threading in caved areas.

Quick-change die heads S and extension fit into the ratchet lever REMS eva and other suitable die stocks.



German Quality Product



Info

### Supply format

**Die heads S Set.** choice of quick-change die heads S for pipe threads tapered, right-hand ISO 7-1, EN 10226 (DIN 2999, BSPT) respectively Taper Pipe Thread ASME B1.20.1, Extension 300 mm. In sturdy steel case.

Description	Art.-No.
Set R 3/8 + 1/2 + 3/4	520025
Set R 1/2 + 3/4 + 1	520026
Set NPT 1/2 + 3/4 + 1	520056



### Accessories

Description	Size	Art.-No.
<b>Ratchet lever</b> for complete work range		522000
<b>Quick-change die heads S</b> Pipe threads tapered, right ISO 7-1, EN 10226 (DIN 2999, BSPT)	R 3/8	521026
	R 1/2	521036
	R 3/4	521046
	R 1	521056
	R 1 1/4	521066
<b>Extension</b> 300 mm		522051
<b>Steel case</b> with inlay for ratchet lever, 4 quick-change die heads S and extension.		526052



Powerful, super handy electric tools for threading with unique support bracket. Ready to use anywhere, without vice. Ideal for repair, renovation, job site.

Pipe threads	1/8 – 1", 16 – 32 mm
Bolt threads	6 – 30 mm, 1/4 – 1"

Thread types see page 30, 31.

## REMS Amigo E – the fastest, strongest and lightest up to 1".

### System advantage

Only **one** type of small, compact quick-change die heads and only **one** type of dies for all REMS die stocks. Thus efficient and easy stocking. No confusion possible.

### Support bracket

Solid, easy to use, supports the die stock against torque in both directions. Secure clamping through angular clamping spindle with self-supporting effect. Very simple mounting of die stock onto support bracket and pipe.

### Design

Compact, robust, job site-proven. Can be used anywhere, even without vice. Slender design for working in confined areas. Drive unit only 3.4 kg, without die head. No heavy top, therefore single-hand operation possible. Perfect, secure seating of quick-change die heads.

### Drive

Solid, compact, maintenance-free gear. Robust, powerful 950 W universal motor with 30 % power increase thanks to automatic carbon brush adjustment while changing the direction of rotation. Peak power input up to 1500 W. Fast threading time 35 – 27 rpm. Safety tip switch.

### Quick-change die heads

Proven technology, high-grade material and precise machining of die head, dies and cover form a unit and ensure an excellent start-cutting performance and easy threading. No stalling of dies. Long, precise pipe guidance for perfect pipe centering. The chip holes which become wider at the outside enable good chip flow and clean threads.

### Dies

The proven, indestructible REMS quality dies with precise cutting geometry ensure an excellent start-cutting performance, easy threading and clean threads. Dies in a high-quality special-grade steel, fully tempered and hardened, for extremely long die life.

### Thread-cutting oil

REMS Sanitol and REMS Spezial (page 49). Specially developed for threading. High cooling and lubricating effect. Essential for clean threads and longer service life of dies, tools and machines.

### Nipple-threading

Efficient with REMS Nippelspanner 3/8 – 1" (2") (page 48).



German Quality Product



Info

## Supply format

**REMS Amigo E Set.** Electric die stock with quick-change die heads. For pipe threads 1/8 – 1", 16 – 32 mm, bolt threads 6 – 30 mm, 1/4 – 1". For right and left-hand threads. Drive unit with maintenance-free gear, powerful universal motor 230 V or 110 V, 50 – 60 Hz, 950 W, safety tip switch, power increase thanks to automatic carbon brush adjustment. Peak power input up to 1500 W. Right and left-hand rotation. Support bracket for both directions. REMS eva quick-change die heads for pipe threads, tapered, ISO 7-1, EN 10226 (DIN 2999, BSPT) R right-hand respectively for threading electric conduit according to EN 60423 M. In sturdy steel case.

Description	Art.-No.
<b>Set R 1/2 + 3/4 + 1</b>	530013
<b>Set M 20 + 25 + 32</b>	530014

REMS Amigo E Set for NPT threads available.

## Accessories

Description	Art.-No.
<b>Quick-change die heads, dies, attachment heads for button dies, see page 30 – 31.</b>	
<b>REMS Amigo E drive unit</b>	530003
<b>Support bracket</b>	533000
<b>REMS REG St 1/4 – 2"</b> , pipe deburrer, see page 99.	731700
<b>Dual purpose holder</b> for threading and sawing with REMS Amigo E, Amigo, Amigo 2 and REMS Tiger	543100
<b>Ratchet lever</b> see page 22.	522000
<b>Thread-cutting oil</b> see page 49.	
<b>REMS Nippelspanner 3/8 – 2"</b> see page 48.	
<b>Steel case with inlay</b>	536000



Powerful, easy-to-operate electric tool for threading with unique support bracket. Ready for use anywhere, without vice. Ideal for repair, renovation, job site.

Pipe threads  $\frac{1}{8}$  –  $1\frac{1}{4}$ " , 16 – 40 mm  
 Bolt threads 6 – 30 mm,  $\frac{1}{4}$  – 1"

Thread types see page 30, 31.

## REMS Amigo – the smallest, lightest, strongest and fastest up to $1\frac{1}{4}$ ".

### System advantage

Only **one** type of small, compact quick-change die heads and only **one** type of dies for all REMS die stocks. Thus efficient and easy stocking. No confusion possible.

### Support bracket

Solid, easy to use, supports the die stock against torque in both directions. Secure clamping through angular clamping spindle with self-supporting effect. Very simple mounting of die stock onto support bracket and pipe.

### Design

Compact, robust, job site-proven. Can be used anywhere, even without vice. Slender design for working in confined areas. Drive unit only 3.5 kg, without die head. No heavy top, therefore single-hand operation possible. Perfect, secure seating of quick-change die heads.

### Drive

Solid, compact, maintenance-free gear. Robust, powerful 1200 W universal motor with 30 % power increase thanks to automatic carbon brush adjustment while changing the direction of rotation. Peak power input up to 1800 W. Fast threading time 35 – 27 rpm. Safety tip switch.

### Quick-change die heads

Proven technology, high-grade material and precise machining of die head, dies and cover form a unit and ensure an excellent start-cutting performance and easy threading. No stalling of dies. Long, precise pipe guidance for perfect pipe centering. The chip holes which become wider at the outside enable good chip flow and clean threads.

### Dies

The proven, indestructible REMS quality dies with precise cutting geometry ensure an excellent start-cutting performance, easy threading and clean threads. Dies in a high-quality special-grade steel, fully tempered and hardened, for extremely long die life.

### Thread-cutting oil

REMS Sanitol and REMS Spezial (page 49). Specially developed for threading. High cooling and lubricating effect. Essential for clean threads and longer service life of dies, tools and machines.

### Nipple-threading

Efficient with REMS Nippelspanner  $\frac{3}{8}$  –  $1\frac{1}{4}$ " (2") (page 48).



German Quality Product



## Supply format

**REMS Amigo Set.** Electric die stock with quick-change die heads. For pipe threads  $\frac{1}{8}$  –  $1\frac{1}{4}$ " , 16 – 40 mm, bolt threads 6 – 30 mm,  $\frac{1}{4}$  – 1". For right and left-hand threads. Drive unit with maintenance-free gear, powerful universal motor 230 V or 110 V, 50 – 60 Hz, 1200 W, safety tip switch, power increase thanks to automatic carbon brush adjustment. Peak power input up to 1800 W. Right and left-hand rotation, overload protection switch. Support bracket for both directions. REMS eva quick-change die heads for pipe threads, tapered, ISO 7-1, EN 10226 (DIN 2999, BSPT) R right-hand respectively for threading electric conduit according to EN 60423 M. In sturdy steel case.

Description	Art.-No.
Set R $\frac{1}{2}$ + $\frac{3}{4}$ + 1 + $1\frac{1}{4}$	530020
Set M 16 + 20 + 25 + 32 (M x 1,5)	530022
Set M 20 + 25 + 32 + 40 (M x 1,5)	530023

REMS Amigo Set for NPT threads available.

## Accessories

Description	Art.-No.
<b>Quick-change die heads, dies, attachment heads for button dies, see page 30 – 31.</b>	
<b>REMS Amigo drive unit</b>	530000
<b>Support bracket</b>	533000
<b>REMS REG St <math>\frac{1}{4}</math> – 2"</b> , pipe deburrer, see page 99.	731700
<b>Dual purpose holder</b> for threading and sawing with REMS Amigo E, Amigo, Amigo 2 and REMS Tiger	543100
<b>Ratchet lever</b> see page 22.	522000
<b>Thread-cutting oil</b> see page 49.	
<b>REMS Nippelspanner <math>\frac{3}{8}</math> – 2"</b> see page 48.	
<b>Steel case</b> with inlay	536000



# REMS Amigo 2

Electric die stock with quick-change die heads

Powerful, easy-to-operate electric tool for threading with unique support bracket. Ready for use any-where, without vice. Ideal for repair, renovation, job site.

Pipe threads	1/8" – 2", 16 – 50 mm
Bolt threads	6 – 30 mm, 1/4" – 1"

Thread types see page 30, 31.

## REMS Amigo 2 – extremely strong up to 2".

### System advantage

Only **one** type of small, compact quick-change die heads and only **one** type of dies for all REMS die stocks. Thus efficient and easy stocking. No confusion possible.

### Support bracket

Solid, easy to use, supports the die stock against torque in both directions. Secure clamping through angular clamping spindle with self-supporting effect. Very simple mounting of die stock onto support bracket and pipe.

### Design

Compact, robust, job site-proven. Can be used anywhere, even without vice. Slender design for working in confined areas. Drive unit only 6.5 kg, without die head.

### Drive

Solid, maintenance-free gear. Robust 1700 W universal motor with 30 % power increase thanks to automatic carbon brush adjustment while changing the direction of rotation. Fast threading time 30 – 18 rpm. Safety tip switch.

### Quick-change die heads

Proven technology, high-grade material and precise machining of die head, dies and cover form a unit and ensure an excellent start-cutting performance and easy threading. No stalling of dies. Long, precise pipe guidance for perfect pipe centering. The chip holes which become wider at the outside enable good chip flow and clean threads.

### Dies

The proven, indestructible REMS quality dies with precise cutting geometry ensure an excellent start-cutting performance, easy threading and clean threads. Dies in a high-quality special-grade steel, fully tempered and hardened, for extremely long die life.

### Thread-cutting oil

REMS Sanitol and REMS Spezial (page 49). Specially developed for threading. High cooling and lubricating effect. Essential for clean threads and longer service life of dies, tools and machines.

### Nipple-threading

Efficient with REMS Nippelspanner 3/8" – 1" (2") (page 48).



German Quality Product



Info



## Supply format

**REMS Amigo 2 Set.** Electric die stock with quick-change die heads. For pipe threads 1/8" – 2", 16 – 50 mm, bolt threads 6 – 30 mm, 1/4" – 1". For right and left-hand threads. Drive unit with maintenance-free gear, powerful universal motor 230 V or 110 V, 50 – 60 Hz, 1700 W, safety tip switch, power increase thanks to automatic carbon brush adjustment, right and left-hand rotation. Support bracket for both directions. REMS eva quick-change die heads for pipe threads, tapered, ISO 7-1, EN 10226 (DIN 2999, BSPT) R right-hand respectively for threading electric conduit according to EN 60423 M. In sturdy steel case.

Description	Art.-No.
Set R 1/2 + 3/4 + 1 + 1 1/4 + 1 1/2 + 2	540020
Set M 20 + 25 + 32 + 40 + 50 (M x 1,5)	540022

REMS Amigo 2 Set for NPT threads available.  
Other voltages on request.



## Accessories

Description	Art.-No.
<b>Quick-change die heads, dies, attachment heads for button dies, see page 30 – 31.</b>	
<b>REMS Amigo 2 drive unit</b>	540000
<b>Support bracket Amigo 2</b>	543000
<b>REMS REG St 1/4" – 2"</b> , pipe deburrer, see page 99.	731700
<b>Dual purpose holder</b> for threading and sawing with REMS Amigo E, Amigo, Amigo 2 and REMS Tiger	543100
<b>Ratchet lever</b> see page 22.	522000
<b>Thread-cutting oil</b> see page 49.	
<b>REMS Nippelspanner 3/8" – 2"</b> see page 48.	
<b>Steel case with inlay</b>	546000



# REMS Amigo 2 Compact

Electric die stock with quick-change die heads

Powerful, easy-to-operate electric tool for threading with unique support bracket. Ready for use any-where, without vice. Ideal for repair, renovation, job site.

Pipe threads  $\frac{1}{8}$  – 2", 16 – 50 mm  
 Bolt threads 6 – 30 mm,  $\frac{1}{4}$  – 1"

Thread types see page 30, 31.

## REMS Amigo 2 Compact – The smallest and lightest up to 2".

### System advantage

Only **one** type of small, compact quick-change die heads and only **one** type of dies for all REMS die stocks. Thus efficient and easy stocking. No confusion possible.

### Support bracket

Solid, easy to use, supports the die stock against torque in both directions. Secure clamping through angular clamping spindle with self-supporting effect. Very simple mounting of die stock onto support bracket and pipe.

### Design

Compact, robust, job site-proven. Can be used anywhere, even without vice. Slender design for working in confined areas. Drive unit only 4.9 kg, without die head. Perfect seating of quick-change die heads.

### Drive

Solid, maintenance-free gear. Robust 1200 W universal motor with 30 % power increase thanks to automatic carbon brush adjustment while changing the direction of rotation. Peak power input up to 1800 W. Fast threading time 30 – 18 rpm. Safety tip switch.

### Quick-change die heads

Proven technology, high-grade material and precise machining of die head, dies and cover form a unit and ensure an excellent start-cutting performance and easy threading. No stalling of dies. Long, precise pipe guidance for perfect pipe centering. The chip holes which become wider at the outside enable good chip flow and clean threads.

### Dies

The proven, indestructible REMS quality dies with precise cutting geometry ensure an excellent start-cutting performance, easy threading and clean threads. Dies in a high-quality special-grade steel, fully tempered and hardened, for extremely long die life.

### Thread-cutting oil

REMS Sanitol and REMS Spezial (page 49). Specially developed for threading. High cooling and lubricating effect. Essential for clean threads and longer service life of dies, tools and machines.

### Nipple-threading

Efficient with REMS Nippelspanner  $\frac{3}{8}$  – 1" (2") (page 48).



German Quality Product



Info



## Supply format

**REMS Amigo 2 Compact Set.** Electric die stock with quick-change die heads. For pipe threads  $\frac{1}{8}$  – 2", 16 – 50 mm, bolt threads 6 – 30 mm,  $\frac{1}{4}$  – 1". For right and left-hand threads. Drive unit with maintenance-free gear, powerful universal motor 230 V or 110 V, 50 – 60 Hz, 1200 W, safety tip switch, power increase thanks to automatic carbon brush adjustment. Peak power input up to 1800 W. Right and left-hand rotation. Overload protection. Support bracket for both directions. REMS eva quick-change die heads for pipe threads, tapered, ISO 7-1, EN 10226 (DIN 2999, BSPT) R right-hand respectively for threading electric conduit according to DIN DN 60423 M. In sturdy steel case.

Description	Art.-No.
Set R $\frac{1}{2}$ + $\frac{3}{4}$ + 1 + 1 $\frac{1}{4}$	540023
Set R $\frac{1}{2}$ + $\frac{3}{4}$ + 1 + 1 $\frac{1}{4}$ + 1 $\frac{1}{2}$ + 2	540024
Set M 20 + 25 + 32 + 40 + 50 (M x 1,5)	540025

REMS Amigo 2 Compact Set for NPT threads available.  
 Other voltages on request.



## Accessories

Description	Art.-No.
<b>Quick-change die heads, dies, attachment heads for button dies, see page 30 – 31.</b>	
<b>REMS Amigo 2 Compact drive unit</b>	540001
<b>Support bracket Amigo 2 Compact</b>	543010
<b>REMS REG St <math>\frac{1}{4}</math> – 2"</b> , pipe deburrer, see page 99.	731700
<b>Ratchet lever</b> see page 22.	522000
<b>Thread-cutting oil</b> see page 49.	
<b>REMS Nippelspanner <math>\frac{3}{8}</math> – 2"</b> see page 48.	
<b>Steel case with inlay</b>	546000



# REMS Amigo 22V

Cordless die stock with quick-change die heads

Powerful, mobile, handy electric tool for threading with unique support bracket. Ready for use any-where, without vice. Ideal for repair, renovation, job site. Li-Ion 22V Technology. For battery and corded operation.

Pipe threads	1/8 – 1", 16 – 32 mm
Bolt threads	6 – 30 mm, 1/4 – 1"

Thread types see page 30, 31.

## REMS Amigo 22V – mobile, handy, light.

Li-Ion 21.6V, 9.0 Ah battery, for approx. 52 3/4" threads with one battery charge\*.

### System advantage

Only **one** type of small, compact quick-change die heads and only **one** type of dies for all REMS die stocks. Thus efficient and easy stocking. No confusion possible.

### Support bracket

Solid, easy to use, supports the die stock against torque in both directions. Secure clamping through angular clamping spindle with self-supporting effect. Very simple mounting of die stock onto support bracket and pipe.

### Design

Compact, robust, job site-proven. Can be used anywhere, even without vice. Slender design for working in confined areas. Mobile, handy, light. Drive unit with battery pack weighs only 5.6 kg. Practical D-shaped handle with soft grip. Perfect seating of quick-change die heads. Machine status check with overload protection of the drive unit against too high currents, with overheating protection by motor temperature monitoring (NTC), with electronic battery charging status check by a 2-coloured green/red LED.

### Drive

Solid, maintenance-free gear. Powerful battery motor 21.6V, with large power reserve, 500W output. High cutting speed 27 – 20 rpm. Safety tip switch.

### Battery or mains operation

Li-Ion 22V Technology. Highly resistant Li-Ion 21.6V batteries with 9.0Ah capacity for long service life. Light and powerful, for 52 3/4" threads with one battery charge\*. Graduated charging status check by coloured LEDs. Operating temperature range –10 to +60 °C. No memory effect for maximum battery power. Rapid charger 100 – 240V, 90W. Rapid charger 100 – 240V, 290W, for shorter charging times, as accessory. Voltage supply 220 – 240V/21.6V, 40A output, for mains operation instead of Li-Ion battery 21.6V, as accessory.

### Quick-change die heads

Proven technology, high-grade material and precise machining of die head, dies and cover form a unit and ensure an excellent start-cutting performance and easy threading. No stalling of dies. Long, precise pipe guidance for perfect pipe centering. The chip holes which become wider at the outside enable good chip flow and clean threads.

### Dies

The proven, indestructible REMS quality dies with precise cutting geometry ensure an excellent start-cutting performance, easy threading and clean threads. Dies in a high-quality special-grade steel, fully tempered and hardened, for extremely long die life.

### Thread-cutting oil

REMS Sanitol and REMS Spezial (page 49). Specially developed for threading. High cooling and lubricating effect. Essential for clean threads and longer service life of dies, tools and machines.

### Nipple-threading

Efficient with REMS Nippelspanner 3/8 – 1" (2") (page 48).



German Quality Product



Info



## Supply format

**REMS Amigo 22V Set.** Cordless die stock with quick-change die heads. For pipe threads  $\frac{1}{8}$ –1", 16–32 mm, bolt threads 6–30 mm,  $\frac{1}{4}$ –1". For right and left-hand threads. Drive unit with maintenance-free gear, powerful battery motor 21.6V, 500 W. Safety switch. Right and left-hand rotation, machine status check with overload protection, temperature monitoring, battery charging status check. Li-Ion 21.6V, 9.0Ah battery, 100–240V, 50–60 Hz, 90 W rapid charger. Support bracket for both directions. REMS eva quick-change die heads for pipe threads, tapered, ISO 7-1, EN 10226 (DIN 2999, BSPT) R right-hand respectively for threading electric conduit according to DIN DN 60423 M. In sturdy steel case.

Description	Art.-No.
<b>Set R <math>\frac{1}{2}</math> + <math>\frac{3}{4}</math> + 1</b>	530015
<b>Set M 20 + 25 + 32</b>	530016

REMS Amigo 22V Set for NPT threads available.  
Other voltages on request.



## Accessories

Description	Art.-No.
<b>Quick-change die heads, dies, attachment heads for button dies, see page 30–31.</b>	
<b>REMS Akku-Amigo 22V drive unit, without battery</b>	530004
<b>Support bracket Amigo 2 Compact</b>	543010
<b>Battery Li-Ion 21.6V, 9.0Ah</b>	571583
<b>Rapid charger 100–240V, 50–60 Hz, 90W</b>	571585
<b>Rapid charger 100–240V, 50–60 Hz, 290W</b>	571587
<b>Voltage supply 220–240V/21.6V, 50–60 Hz, 40A, for mains operation instead of battery Li-Ion 21.6V</b>	571578
<b>REMS REG St <math>\frac{1}{4}</math>–2", pipe deburrer, see page 99.</b>	731700
<b>Ratchet lever see page 22.</b>	522000
<b>Thread-cutting oil see page 49.</b>	
<b>REMS Nippelspanner <math>\frac{3}{8}</math>–2" see page 48.</b>	
<b>Steel case with inlay</b>	566030
<b>REMS Lumen 2800 22V, cordless LED flood light, see page 111</b>	





# REMS quick-change die heads

Accessories for REMS die stocks and other makes

## REMS quick-change die heads

Proven technology, high-grade material and precise machining of die head, dies and cover form a unit and ensure an excellent start-cutting performance and easy threading. No stalling of dies. Long, precise pipe guidance for perfect pipe centering. The chip holes which become wider at the outside enable good chip flow and clean threads.

Thread type	Size	Art.-No.
Pipe threads R tapered, right-hand ISO 7-1, EN 10226 (DIN 2999, BSPT)	R 1/8	521000
	R 1/4	521010
	R 3/8	521020
	R 1/2	521030
	R 3/4	521040
	R 1	521050
	R 1 1/4	521060
	R 1 1/2	521070
	R 2	521080
Pipe threads R tapered, left-hand ISO 7-1, EN 10226 (DIN 2999, BSPT)	R 1/8 LH	521100
	R 1/4 LH	521110
	R 3/8 LH	521120
	R 1/2 LH	521130
	R 3/4 LH	521140
	R 1 LH	521150
	R 1 1/4 LH	521160
	R 1 1/2 LH	521170
R 2 LH	521180	
Pipe threads NPT tapered, right-hand Taper Pipe Thread ASME B1.20.1	NPT 1/8	521200
	NPT 1/4	521210
	NPT 3/8	521220
	NPT 1/2	521230
	NPT 3/4	521240
	NPT 1	521250
	NPT 1 1/4	521260
	NPT 1 1/2	521270
	NPT 2	521280
Threads M for electric conduit EN 60423	M 16 x 1.5	521300
	M 20 x 1.5	521310
	M 25 x 1.5	521320
	M 32 x 1.5	521330
	M 40 x 1.5	521340
	M 50 x 1.5	521350



Right-hand pipe thread



Left-hand pipe thread

German Quality Product

# REMS dies

Accessories for REMS die stocks

## REMS dies

The proven, indestructible REMS quality dies with precise cutting geometry ensure an excellent start-cutting performance, easy threading and clean threads. Dies in a high-quality special-grade steel, fully tempered and hardened, for extremely long die life.

Thread type	Size	Art.-No.
Pipe threads R tapered, right-hand ISO 7-1, EN 10226 (DIN 2999, BSPT)	R 1/8	521002
	R 1/4	521012
	R 3/8	521022
	R 1/2	521032
	R 3/4	521042
	R 1	521052
	R 1 1/4	521062
	R 1 1/2	521072
	R 2	521082
Pipe threads R tapered, left-hand ISO 7-1, EN 10226 (DIN 2999, BSPT)	R 1/8 LH	521102
	R 1/4 LH	521112
	R 3/8 LH	521122
	R 1/2 LH	521132
	R 3/4 LH	521142
	R 1 LH	521152
	R 1 1/4 LH	521162
	R 1 1/2 LH	521172
R 2 LH	521182	
Pipe threads NPT tapered, right-hand Taper Pipe Thread ASME B1.20.1	NPT 1/8	521202
	NPT 1/4	521212
	NPT 3/8	521222
	NPT 1/2	521232
	NPT 3/4	521242
	NPT 1	521252
	NPT 1 1/4	521262
	NPT 1 1/2	521272
	NPT 2	521282
Threads M for electric conduit EN 60423	M 16 x 1.5	521302
	M 20 x 1.5	521312
	M 25 x 1.5	521322
	M 32 x 1.5	521332
	M 40 x 1.5	521342
	M 50 x 1.5	521352



German Quality Product

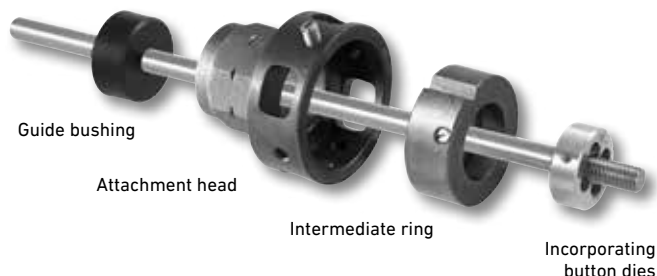

**Attachment heads**

Attachment heads for incorporating standard, round button dies of all thread types. Locking of button dies to the attachment head with stud bolt.

Description	Size	Art.-No.
Attachment head for button dies	Ø 65 mm	731200
Attachment head for button dies	G 1¼	731250
Attachment head for button dies	Ø 105 mm	541401

**Intermediate rings**

Intermediate rings for different outside diameters of button dies.

Description	Size	I.D. mm	Art.-No.
Intermediate rings to attachment head 731200	M 6-9	20/25	731205
	M 10-11	30	731210
	M 12-14 (Pg 7-9)	38	731220
	M 16-20 (Pg 11-13,5)	45	731230
	M 22-24 (Pg 16)	55	731240
without intermediate ring	M 27-30 (Pg 21-29)	65	
Intermediate rings to attachment head 541401	Ø 65/105 (Pg 21-29)	65	541404
	Ø 75/105	75	541406
	Ø 90/105 (Pg 36)	90	541410
without intermediate ring	Pg 42-48	105	

**Guide bushings**

Guide bushings for easy and concentric start-cutting.

Description	Size	Art.-No.
Guide bushings to attachment head 731200	Ø 6	731301
	Ø 8	731302
	Ø 10	731303
	Ø 12	731304
	Ø 14	731305
	Ø 16	731306
	Ø 18	731307
	Ø 20	731308
	Ø 22	731309
	Ø 24	731310
	Ø 27	731311
	Ø 30	731312
	Ø 12.8 (Pg 7)	731320
	Ø 15.5 (Pg 9)	731321
	Ø 18.9 (Pg 11)	731322
	Ø 20.7 (Pg 13.5)	731323
	Ø 22.8 (Pg 16)	731324
Ø 28.6 (Pg 21)	731325	
Ø 37.3 (Pg 29)	731326	
Guide bushings to attachment head 541401	Ø 28.6 (Pg 21)	541413
	Ø 37.3 (Pg 29)	541414
	Ø 47.3 (Pg 36)	541415
	Ø 54.3 (Pg 42)	541416

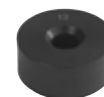

German Quality Product

Proven high performance machine for threading, cutting, deburring, threading of nipples, roll grooving.

For installation, metalworking, industry.

For job site and workshop.

Pipe threads (1/16) 1/8–2", 16–63 mm

Bolt threads (6) 10–60 mm, 1/4–2"

Thread types see page 40.

Pipe grooving with

REMS roll grooving attachment DN 25–200  
1–8"

### REMS Tornado – a class of its own.

**Automatic chuck. Universal automatic die head.**

**Automatic lubrication and cooling.**

#### Operating principle

Rotating material - stationary tools.

#### Design

Robust, job site-proven. Favourable size and weight, e.g. REMS Tornado 2000 complete only 50 kg. Large work and chip compartment. Easy handling of chip tray. Adjustable height material support.

#### 2 versions:

- Portable version with 3 tubular legs, with removable large oil basin and chip tray.
- Version T with integrated, even larger oil basin and chip tray. For workbench. Stand, collapsible wheel stand or wheel stand with material shelf, as an accessory, for easy transport, optimum working height and stable positioning.

#### Drive

Extremely powerful and fast, e.g. R 2" thread in only 15 s. Completely maintenance-free gear which runs in a sealed oil bath.

#### Choice of 3 powerful motors:

- Strong universal motor, 1700 W. overload protection. Spindle speed 53 rpm.
- Pole-reversible capacitor motor, 2100 W. Overload protection. 2 spindle speeds 52 and 26 rpm, also under full load. **Extremely quiet running.**
- Pole-reversible 3-induction motor, 2000 W. Overload protection. 2 spindle speeds 52 and 26 rpm, also under full load. **Extremely quiet running.**

Operator-friendly safety foot switch with emergency-stop, 2-step. Foot switch, can be loaded with the full body weight during operation.

#### Automatic chuck

2 automatic chucks with self-centering clamping jaws for easy and fast clamping and release of the material. Self-tightening, hence maximum clamping force. No slipping of pipes. Collets are available for clamping pipes <math>\varnothing 1/8''</math> and bolts <math>< \varnothing 10 \text{ mm}</math>.

#### Automatic lubrication and cooling

Robust, proven oil pump with high pumping volume. Optimized oil distribution directly onto the threading point through the die head ensures clean threads and long service life of dies, gear and motor.

#### Universal automatic die head

Only **one** universal automatic die head for all threads, including long threads; automatic opening with automatic thread-length-stop for tapered threads. Fast and easy adjustment of thread size. Easy-to-read thread-size scale. Simple and fast change of dies through lock-in positioning in die holder.

#### Dies

The proven, indestructible REMS quality dies with precise cutting geometry ensure an excellent start-cutting performance, easy threading and clean threads. Dies in a high-quality special-grade steel, fully tempered and hardened, for extremely long die life.

#### Pipe cutter

Self centering. Robust body made of forged steel. Ergonomic, wide handle for powerful infeed of spindle. Specially hardened cutter wheel in tough-hard REMS die-steel ensures long service life.

#### Inner pipe deburrer

Robust, easy-to-handle deburring device with adjustable deburring positioning. Specially hardened and designed deburring blade ensures easy deburring and extremely long service life. Two cutting edges for optimum chip flow, specially for small diameters.

#### Thread-cutting oil

REMS Sanitol and REMS Spezial (page 49). Specially developed for threading. High cooling and lubricating effect. Essential for clean threads and longer service life of dies, tools and machines.

#### Nipple-threading

Efficient with the automatic internal clamping REMS Nippelfix 1/2–2" (4") or with the manual internal clamping REMS Nippelspanner 3/8–2" (page 48).



German Quality Product



Info



Choice of 3 powerful motors.



### REMS roll grooving attachment

Robust, compact roll grooving attachment with oil hydraulic in-feed for pipe grooving of grooved coupling systems DN 25–300, 1–12" (page 50). Roll grooving with REMS Tornado up to DN 200, 8".



Version T

Wheel stand (accessory)



Version T

Collapsible wheel stand (Accessory)

### Supply format

**REMS Tornado.** Threading machine for pipe threads ( $\frac{1}{16}$ – $2$ "  $\frac{1}{8}$ – $2$ "  $\frac{1}{4}$ – $2$ ". With maintenance-free gear, safety foot switch with emergency-stop, 2 automatic chucks, automatic lubrication and cooling. With tool set consisting of one universal automatic die head for all threads, also long threads, automatic opening, with automatic thread-length-stop for tapered threads. Dies for pipe threads, tapered, ISO 7-1, EN 10226 (DIN 2999, BSPT) R  $\frac{1}{2}$ – $\frac{3}{4}$ " and R 1– $2$ " right-hand, pipe cutter, inner pipe deburrer, pressing lever, adjustable height material support. Choice of 3 motors. Portable version with 3 tubular legs, with removable, large oil and chip tray. Version T with integrated, even bigger oil tray and chip tray, for workbench, stand, collapsible wheel stand or wheel stand with material shelf. In a carton.

Description	Version	Art.-No.
<b>2000</b>	Universal motor 230 V or 110 V, 50–60 Hz, 1700 W. 53 rpm. Portable, 3 legs.	340200
<b>2010</b>	Pole-reversible capacitor, motor 230 V, 50 Hz, 2100 W. 52/26 rpm, also under full load. Extremely quiet running. Portable, 3 legs.	340201
<b>2020</b>	Pole-reversible 3~ induction motor 400 V, 50 Hz, 2000 W. 52/26 rpm, also under full load. Extremely quiet running. Portable, 3 legs.	340202
<b>2000 T</b>	Universal motor 230 V or 110 V, 50–60 Hz, 1700 W. 53 rpm For work bench, stand or wheel stand.	340206
<b>2010 T</b>	Pole-reversible capacitor motor 230 V, 50 Hz, 2100 W. 52/26 rpm, also under full load. Extremely quiet running. For work bench, stand or wheel stand.	340207
<b>2020 T</b>	Pole-reversible 3~ induction motor 400 V, 50 Hz, 2000 W. 52/26 rpm, also under full load. Extremely quiet running. For work bench, stand or wheel stand.	340208

Other voltages and NPT versions on request.

### Accessories

Description	Art.-No.
<b>Stand</b>	344105
<b>Wheel stand with material shelf</b>	344100
<b>Collapsible wheel stand</b>	344150
<b>Dies</b> see page 40.	
<b>Universal automatic die head <math>\frac{1}{16}</math>–<math>2</math>"</b> quick-change die head instead of changing the dies	341000
<b>REMS cutter wheel St <math>\frac{1}{8}</math>–<math>4</math>", s 8</b>	341614
<b>Thread-cutting oil</b> see page 49.	
<b>Nipple holder</b> see page 48.	
<b>REMS Herkules</b> material supports, see page 107.	
<b>REMS roll grooving attachment</b> for pipe grooving, see page 50.	347000



Robust, compact high performance machine for threading, cutting, deburring, threading of nipples, roll grooving. For installation, metalworking, industry. For job site and workshop.

Pipe threads	( $\frac{1}{16}$ ) $\frac{1}{8}$ – 2", 16 – 63 mm
Bolt threads	(6) 8 – 60 mm, $\frac{1}{4}$ – 2"

Thread types see page 40.

Grooving of pipes with REMS roll grooving attachment	DN 25 – 300 1 – 12"
---	------------------------

### REMS Magnum – the compact up to 2".

#### Operating principle

Rotating material – stationary tools.

#### Design

Robust, compact, job site-proven design. Favorable size and weight, e.g. REMS Magnum 2000 L-T only 62 kg. Large work and chip compartment. Tool support.

#### 2 versions:

- Light version L-T with removable large oil basin and chip tray.
  - Version T with integrated, even larger oil basin and chip tray.
- For workbench. Stand, collapsible wheel stand or wheel stand with material shelf, as an accessory, for easy transport, optimum working height and stable positioning.

#### Drive

Extremely powerful and fast, e.g. thread R 2" in only 15 s. Completely maintenance-free gear which runs in a sealed oil bath.

#### Choice of 3 powerful motors:

- Strong universal motor, 1700 W.  
Overload protection. Spindle speed 53 rpm.
- Pole-reversible capacitor motor, 2100 W.  
Overload protection. 2 spindle speeds 52 and 26 rpm, also under full load. **Extremely quiet running.**
- Pole-reversible 3~ induction motor, 2000 W.  
Overload protection. 2 spindle speeds 52 and 26 rpm, also under full load. **Extremely quiet running.**

Operator-friendly safety foot switch with emergency-stop, 2-step. Foot switch, can be loaded with the full body weight during operation.

#### Chuck

Proven quick-action hammer chuck, self-tightening. No slipping of pipes. Large space between chuck and centering device ensures secure clamping of long pipes. Rear centering device for alignment of the material. Collets are available for clamping pipes <math>\varnothing \frac{1}{8}</math>" and bolts <math>< \varnothing 8</math> mm.

#### Automatic lubrication and cooling

Robust, proven oil pump with high pumping volume. Optimized oil distribution directly onto the threading point through the die head ensures clean threads and long service life of dies, gear and motor.

#### Universal automatic die head

Only **one** universal automatic die head for all threads, including long threads; automatic opening with automatic thread-length-stop for tapered threads. Fast and easy adjustment of thread size. Simple and fast change of dies through lock-in positioning in die holder.

#### Dies

The proven, indestructible REMS quality dies with precise cutting geometry ensure an excellent start-cutting performance, easy threading and clean threads. Dies in a high-quality special-grade steel, fully tempered and hardened, for extremely long die life.

#### Pipe cutter

Self centering. Robust body made of forged steel. Ergonomic, wide handle for powerful infeed of spindle. Specially hardened cutter wheel in tough-hard REMS die-steel ensures long service life.

#### Inner pipe deburrer

Robust, easy-to-handle deburring device for adjustable deburring positioning. Specially hardened and designed deburring blade ensures easy deburring and extremely long service life. Two cutting edges for optimum chip flow, specially for small diameters.

#### Thread-cutting oil

REMS Sanitol and REMS Spezial (page 49). Specially developed for threading. High cooling and lubricating effect. Essential for clean threads and longer service life of dies, tools and machines.

#### Nipple-threading

Efficient with automatic internal clamping REMS Nippelfix  $\frac{1}{2}$  – 2" (4") or with manual internal clamping REMS Nippelspanner  $\frac{3}{8}$  – 2" (page 48).

#### REMS roll grooving attachment

Robust, compact roll grooving attachment with oil hydraulic in-feed for pipe grooving of grooved coupling systems DN 25–300, 1–12" (page 50).



German Quality Product



Info



Choice of 3 powerful motors.





### Supply format

**REMS Magnum.** Threading machine for pipe threads ( $\frac{1}{16}$ )  $\frac{1}{8}$ –2", 16–63 mm, bolt thread (6) 8–60 mm,  $\frac{1}{4}$ –2". With maintenance-free gear, safety foot switch with emergency-stop, self-tightening quick-action hammer chuck, rear centering device, automatic lubrication and cooling. With complete tool set consisting of one universal automatic die head for all threads, also long threads; automatic opening, with automatic thread-length-stop for tapered threads, dies for pipe threads, tapered, ISO 7-1, EN 10226 (DIN 2999, BSPT) R  $\frac{1}{2}$ – $\frac{3}{4}$ " and R 1–2" right-hand, pipe cutter, inner pipe deburrer, pressing lever. Tool support. Choice of 3 motors. Version L-T with removable large oil basin and chip tray. Version T with integrated, even bigger oil tray and chip tray. For workbench, stand, collapsible wheel stand or wheel stand with material shelf. In a carton.

Description	Version	Art.-No.
<b>2000 L-T</b>	Universal motor 230 V or 110 V, 50–60 Hz, 1700 W. 53 rpm.	340226
<b>2010 L-T</b>	Pole-reversible capacitor motor 230 V, 50 Hz, 2100 W. 52/26 rpm, also under full load. Extremely quiet running.	340227
<b>2020 L-T</b>	Pole-reversible 3~ induction motor 400 V, 50 Hz, 2000 W. 52/26 rpm, also under full load. Extremely quiet running.	340228
<b>2000 T*</b>	Universal motor 230 V or 110 V, 50–60 Hz, 1700 W. 53 rpm.	340220
<b>2010 T*</b>	Pole-reversible capacitor motor 230 V, 50 Hz, 2100 W. 52/26 rpm, also under full load. Extremely quiet running.	340221
<b>2020 T*</b>	Pole-reversible 3~ induction motor 400 V, 50 Hz, 2000 W. 52/26 rpm, also under full load. Extremely quiet running.	340222

Other voltages and NPT versions on request.

\*T versions with REMS roll grooving device for roll grooving can only be used up to DN 200, 8".

### Accessories

Description	Art.-No.
<b>Stand</b>	344105
<b>Wheel stand</b> with material shelf	344100
<b>Collapsible wheel stand</b>	344150
<b>Dies</b> see page 40.	
<b>Universal automatic die head</b> $\frac{1}{16}$ –2" quick-change die head instead of changing the dies	341000
<b>Changeover valve</b> , for reversing flow direction of the coolant-lubricant pump for cutting left-handed threads with REMS Magnum 2010, 2020, 3010, 3020, 4010 and 4020	342080
<b>REMS cutter wheel</b> St $\frac{1}{8}$ –4", s 8	341614
<b>Thread-cutting oil</b> see page 49.	
<b>Nipple holder</b> see page 48.	
<b>REMS Herkules</b> material supports, see page 107.	
<b>REMS roll grooving attachment</b> for pipe grooving, see page 50.	347000



Robust, compact high performance machine for threading, cutting, deburring, threading of nipples, roll grooving. For installation, metalworking, industry. For job site and workshop.

Pipe threads	( $\frac{1}{16}$ ) $\frac{1}{2}$ –3", 16–63 mm
Bolt threads	(6) 18–60 mm, $\frac{1}{2}$ –2"

Thread types see page 40.

Pipe grooving with REMS roll grooving attachment	DN 25–300 1–12"
---	--------------------

**REMS Magnum – the super machine up to 3".  
Exceptionally round and clean threads up to 3"  
by using 5 threading dies.**

### Operating principle

Rotating material – stationary tools.

### Design

Robust, compact, job site-proven design. Favorable size and weight, e.g. REMS Magnum 3000 L-T only 79 kg. Large work and chip compartment. Tool support.

#### 2 versions:

- Light version L-T with removable large oil basin and chip tray.
  - Version T with integrated, even larger oil basin and chip tray.
- For workbench. Stand, collapsible wheel stand or wheel stand with material shelf, as an accessory, for easy transport, optimum working height and stable positioning.

### Drive

Extremely powerful and fast. Completely maintenance-free gear which runs in a sealed oil bath.

#### Choice of 3 powerful motors:

- Strong universal motor, 1700 W.  
Overload protection. Spindle speed 23 rpm.
- Pole-reversible capacitor motor, 2100 W.  
Overload protection. 2 spindle speeds 20 and 10 rpm, also under full load. **Extremely quiet running.**
- Pole-reversible 3~ induction motor, 2000 W.  
Overload protection. 2 spindle speeds 20 and 10 rpm, also under full load. **Extremely quiet running.**

Operator-friendly safety foot switch with emergency-stop, 2-step. Foot switch, can be loaded with the full body weight during operation.

### Chuck

Proven quick-action hammer chuck, self-tightening. No slipping of pipes. Large space between chuck and centering device ensures secure clamping of long pipes. Rear centering device for alignment of the material. Collets are available for clamping pipes <math>\varnothing \frac{1}{2}</math>" and bolts <math>\varnothing 18</math> mm.

### Automatic lubrication and cooling

Robust, proven oil pump with high pumping volume. Optimized oil distribution directly onto the threading point through the die head ensures clean threads and long service life of dies, gear and motor.

### Universal automatic die head

Only 1 universal automatic die head each for the sizes  $\frac{1}{16}$ –2" and 2½–3" for all threads, including long threads; automatic opening with automatic thread-length-stop for tapered threads. 5 dies 2½–3" ensure a favourable distribution of the cutting force onto the pipe, hence round and clean threads. Fast and easy adjustment of thread size. Simple and fast change of dies through lock-in positioning in die holder.

### Dies

The proven, indestructible REMS quality dies with precise cutting geometry ensure an excellent start-cutting performance, easy threading and clean threads. Dies in a high-quality special-grade steel, fully tempered and hardened, for extremely long die life.

### Pipe cutter

Self centering. Robust body made of forged steel. Ergonomic, wide handle for powerful infeed of spindle. Specially hardened cutter wheel in tough-hard REMS die-steel ensures long service life.

### Inner pipe deburrer

Robust, easy-to-handle deburring device for adjustable deburring positioning. Specially hardened and designed deburring blade ensures easy deburring and extremely long service life. Two cutting edges for optimum chip flow, specially for small diameters.

### Tool sets

For 2½–3" and  $\frac{1}{2}$ –2" one complete tool set each adapted to the work range with universal die head, pipe cutter, inner-pipe-deburring device, pressing lever, dies.



German Quality Product



Choice of 3 powerful motors.



### Thread-cutting oil

REMS Sanitol and REMS Spezial (page 49). Specially developed for threading. High cooling and lubricating effect. Essential for clean threads and longer service life of dies, tools and machines.

### Nipple-threading

Efficient with automatic internal clamping REMS Nippelfix ½–3" (4") or with manual internal clamping REMS Nippelspanner (page 48).

### REMS roll grooving attachment

Robust, compact roll grooving attachment with oil hydraulic in-feed for pipe grooving of grooved coupling systems DN 25–300, 1–12" (page 50).

### Supply format

**REMS Magnum.** Threading machine for pipe threads (1/16) ½–3", 16–63 mm, bolt threads (6) 18–60 mm, ½–2". With maintenance-free gear, safety foot switch with emergency-stop, self-tightening quick-action hammer chuck, rear centering device, automatic lubrication and cooling. With tool sets 1/16–2" and/or 2½–3", each consisting of universal automatic die head for all threads, also long threads; automatic opening, with automatic thread-length-stop for tapered threads, dies for pipe threads, tapered, ISO 7-1, EN 10226 (DIN 2999, BSPT) R right-hand, pipe cutter, inner pipe deburrer, pressing lever. Tool support. Choice of 3 motors. Version L-T with removable large oil basin and chip tray. Version T with integrated, even larger oil basin and chip tray. For workbench, stand, collapsible wheel stand or wheel stand with material shelf. In a carton.

Description	Version/Equipment	Art.-No.
<b>3000 L-T</b>	Universal motor 230 V or 110 V, 50–60 Hz, 1700 W. 23 rpm. <b>Equipment R 2½–3</b>	380303
	<b>Equipment R ½–3</b>	380309
<b>3010 L-T</b>	Pole-reversible capacitor motor 230 V, 50 Hz, 2100 W. 20/10 rpm, also under full load. Extremely quiet running. <b>Equipment R 2½–3</b>	380304
	<b>Equipment R ½–3</b>	380310
<b>3020 L-T</b>	Pole-reversible 3~ induction motor 400 V, 50 Hz, 2000 W. 20/10 rpm, also under full load. Extremely quiet running. <b>Equipment R 2½–3</b>	380305
	<b>Equipment R ½–3</b>	380311
<b>3000 T*</b>	Universal motor 230 V or 110 V, 50–60 Hz, 1700 W. 23 rpm. <b>Equipment R 2½–3</b>	380306
	<b>Equipment R ½–3</b>	380312
<b>3010 T*</b>	Pole-reversible capacitor motor 230 V, 50 Hz, 2100 W. 20/10 rpm, also under full load. Extremely quiet running. <b>Equipment R 2½–3</b>	380307
	<b>Equipment R ½–3</b>	380313
<b>3020 T*</b>	Pole-reversible 3~ induction motor 400 V, 50 Hz, 2000 W. 20/10 rpm, also under full load. Extremely quiet running. <b>Equipment R 2½–3</b>	380308
	<b>Equipment R ½–3</b>	380314

Other voltages and NPT versions on request.

\*T versions with REMS roll grooving device for roll grooving can only be used up to DN 200, 8".

### Accessories

Description	Art.-No.
<b>Stand</b>	344105
<b>Wheel stand</b> with material shelf	344100
<b>Collapsible wheel stand</b>	344150
<b>Dies</b> see page 40.	
<b>Tool set R ½–2" complete</b> with universal automatic die head 1/16–2", dies for pipe threads, tapered, ISO 7-1, EN 10226 (DIN 2999, BSPT) R ½–¾" and R 1–2" right-hand, pipe cutter, inner pipe deburrer, pressing lever.	340100
<b>Universal automatic die head</b> 1/16–2" and others	341000
<b>Universal automatic die head</b> 2½–3"	381050
<b>Universal automatic die head</b> 2½–4"	381000
<b>Changeover valve</b> , for reversing flow direction of the coolant-lubricant pump for cutting left-handed threads with REMS Magnum 2010, 2020, 3010, 3020, 4010 and 4020	342080
<b>REMS cutter wheel</b> St ½–4", s 8	341614
<b>REMS cutter wheel</b> St 1–4", s 12	381622
<b>Thread-cutting oil</b> see page 49.	
<b>Nipple holder</b> see page 48.	
<b>REMS Herkules</b> material supports, see page 107.	
<b>REMS roll grooving attachment</b> for pipe grooving, see page 50.	347000

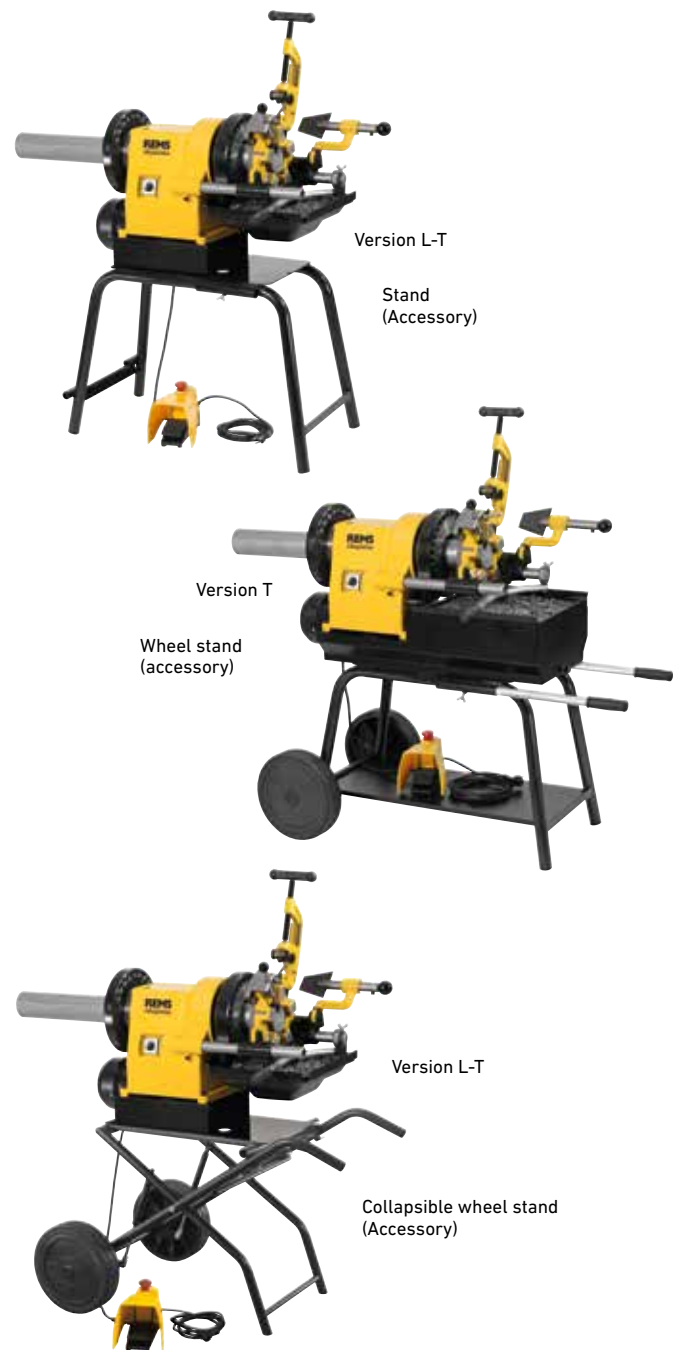



Robust, compact high performance machine for threading, cutting, deburring, threading of nipples, roll grooving. For installation, metalworking, industry. For job site and workshop.

Pipe threads (1/16) 1/2–4", 18–63 mm  
Bolt threads (6) 20–60 mm, 1/2–2"

Thread types see page 40.

Pipe grooving with REMS roll grooving attachment DN 25–300  
1–12"

**REMS Magnum – the super machine up to 4". Exceptionally round and clean threads up to 4" by using 6 threading dies.**

### Operating principle

Rotating material - stationary tools.

### Design

Robust, compact, job site-proven design. Favorable size and weight, e.g. REMS Magnum 4000 L-T only 81 kg. Large work and chip compartment. Tool support.

#### 2 versions:

- Light version L-T with removable large oil basin and chip tray.
  - Version T with integrated, even larger oil basin and chip tray.
- For workbench. Stand, collapsible wheel stand or wheel stand with material shelf, as an accessory, for easy transport, optimum working height and stable positioning.

### Drive

Extremely powerful and fast. Completely maintenance-free gear which runs in a sealed oil bath.

#### Choice of 3 powerful motors:

- Strong universal motor, 1700 W. Overload protection. Spindle speed 23 rpm.
- Pole-reversible capacitor motor, 2100 W. Overload protection. 2 spindle speeds 20 and 10 rpm, also under full load. **Extremely quiet running.**
- Pole-reversible 3~ induction motor, 2000 W. Overload protection. 2 spindle speeds 20 and 10 rpm, also under full load. **Extremely quiet running.**

Operator-friendly safety foot switch with emergency-stop, 2-step. Foot switch, can be loaded with the full body weight during operation.

### Chuck

Proven quick-action hammer chuck, self-tightening. No slipping of pipes. Large space between chuck and centering device ensures secure clamping of long pipes. Rear centering device for alignment of the material. Collets are available for clamping pipes <math>\varnothing</math> 1/2" and bolts <math>\varnothing</math> 18 mm.

### Automatic lubrication and cooling

Robust, proven oil pump with high pumping volume. Optimized oil distribution directly onto the threading point through the die head ensures clean threads and long service life of dies, gear and motor.

### Universal automatic die head

Only 1 universal automatic die head each for the sizes 1/16–2" and 2 1/2–4" for all threads, including long threads; automatic opening with automatic thread-length-stop for tapered threads. 6 dies 2 1/2–4" ensure a favourable distribution of the cutting force onto the pipe, hence round and clean threads. Fast and easy adjustment of thread size. Simple and fast change of dies through lock-in positioning in die holder.

### Dies

The proven, indestructible REMS quality dies with precise cutting geometry ensure an excellent start-cutting performance, easy threading and clean threads. Dies in a high-quality special-grade steel, fully tempered and hardened, for extremely long die life.

### Pipe cutter

Self centering. Robust body made of forged steel. Ergonomic, wide handle for powerful infeed of spindle. Specially hardened cutter wheel in tough-hard REMS die-steel ensures long service life.

### Inner pipe deburrer

Robust, easy-to-handle deburring device for adjustable deburring positioning. Specially hardened and designed deburring blade ensures easy deburring and extremely long service life. Two cutting edges for optimum chip flow, specially for small diameters.

### Tool sets

For 2 1/2–4" and 1/2–2" one complete tool set each adapted to the work range with universal die head, pipe cutter, inner-pipe-deburring device, pressing lever, dies.



German Quality Product



Choice of 3 powerful motors.



### Thread-cutting oil

REMS Sanitol and REMS Spezial (page 49). Specially developed for threading. High cooling and lubricating effect. Essential for clean threads and longer service life of dies, tools and machines.

### Nipple-threading

Efficient with automatic internal clamping REMS Nippelfix ½–4" or with manual internal clamping REMS Nippelspanner ¾–2" (page 48).

### REMS roll grooving attachment

Robust, compact roll grooving attachment with oil hydraulic in-feed for pipe grooving of grooved coupling systems DN 25–300, 1–12" (page 50).

### Supply format

**REMS Magnum.** Threading machine for pipe threads (1/16) ½–4", 16–63 mm, bolt threads (6) 18–60 mm, ½–2". With maintenance-free gear, safety foot switch with emergency-stop, self-tightening quick-action hammer chuck, rear centering device, automatic lubrication and cooling. With tool sets 1/16–2" and/or 2 1/2–4", each consisting of universal automatic die head for all threads, also long threads; automatic opening, with automatic thread-length-stop for tapered threads, dies for pipe threads, tapered, ISO 7-1, EN 10226 (DIN 2999, BSPT) R right-hand, pipe cutter, inner pipe deburrer, pressing lever. Tool support. Choice of 3 motors. Version L-T with removable large oil basin and chip tray. Version T with integrated, even larger oil basin and chip tray. For workbench, stand, collapsible wheel stand or wheel stand with material shelf. In a carton.

Description	Version/Equipment	Art.-No.
<b>4000 L-T</b>	Universal motor 230 V or 110 V, 50–60 Hz, 1700 W. 23 rpm.	
	<b>Equipment R ½–2</b>	380447
	<b>Equipment R 2 1/2–4</b>	380441
	<b>Equipment R ½–4</b>	380444
<b>4010 L-T</b>	Pole-reversible capacitor motor 230 V, 50 Hz, 2100 W. 20/10 rpm, also under full load. Extremely quiet running.	
	<b>Equipment R ½–2</b>	380448
	<b>Equipment R 2 1/2–4</b>	380442
	<b>Equipment R ½–4</b>	380445
<b>4020 L-T</b>	Pole-reversible 3~ induction motor 400 V, 50 Hz, 2000 W. 20/10 rpm, also under full load. Extremely quiet running.	
	<b>Equipment R 2 1/2–4</b>	380443
	<b>Equipment R ½–4</b>	380446
<b>4000 T*</b>	Universal motor 230 V or 110 V, 50–60 Hz, 1700 W. 23 rpm.	
	<b>Equipment R 2 1/2–4</b>	380426
	<b>Equipment R ½–4</b>	380429
<b>4010 T*</b>	Pole-reversible capacitor motor 230 V, 50 Hz, 2100 W. 20/10 rpm, also under full load. Extremely quiet running.	
	<b>Equipment R 2 1/2–4</b>	380427
	<b>Equipment R ½–4</b>	380430
<b>4020 T*</b>	Pole-reversible 3~ induction motor 400 V, 50 Hz, 2000 W. 20/10 rpm, also under full load. Extremely quiet running.	
	<b>Equipment R 2 1/2–4</b>	380428
	<b>Equipment R ½–4</b>	380431

Other voltages and NPT versions on request.

\*T versions with REMS roll grooving device for roll grooving can only be used up to DN 200, 8".

### Accessories

Description	Art.-No.
<b>Stand</b>	344105
<b>Wheel stand</b> with material shelf	344100
<b>Collapsible wheel stand</b>	344150
<b>Dies</b> see page 40.	
<b>Tool set R ½–2" complete</b> with universal automatic die head 1/16–2", dies for pipe threads, tapered, ISO 7-1, EN 10226 (DIN 2999, BSPT) R ½–¾" and R 1–2" right-hand, pipe cutter, inner pipe deburrer, pressing lever.	340100
<b>Universal automatic die head 1/16–2" and others</b>	341000
<b>Universal automatic die head 2 1/2–4"</b>	381000
<b>Changeover valve</b> , for reversing flow direction of the coolant-lubricant pump for cutting left-handed threads with REMS Magnum 2010, 2020, 3010, 3020, 4010 and 4020	342080
<b>REMS cutter wheel St 1/8–4", s 8</b>	341614
<b>REMS cutter wheel St 1–4", s 12</b>	381622
<b>Thread-cutting oil</b> see page 49.	
<b>Nipple holder</b> see page 48.	
<b>REMS Herkules material supports</b> , see page 107.	
<b>REMS roll grooving attachment</b> for pipe grooving, see page 50.	347000



## REMS dies (set)

The proven REMS quality dies with precise cutting geometry ensure an excellent start-cutting performance, easy threading and clean threads. Dies in a high-quality special-grade steel, fully tempered and hardened, for materials < 500 N/mm<sup>2</sup> (MPa) for extremely long die life.

Dies for other threads (e.g. BSW) on request. HSS dies for materials that are difficult to cut ≥ 500 N/mm<sup>2</sup> (MPa) 50 % surcharge.

<sup>1)</sup> Some dies only available in HSS.

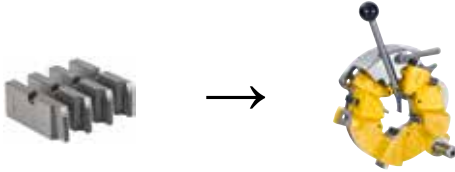

### For universal automatic die head 1/16 – 2"

Thread type	Size	Art.-No.
Pipe threads R tapered, right-hand ISO 7-1, EN 10226 (DIN 2999, BSPT)	R 1/16 – 1/8 HSS <sup>1)</sup>	341401
	R 1/4 – 3/8	341402
	R 1/2 – 3/4	341403
	R 1 – 2	341404
Pipe threads G parallel, right-hand ISO 228-1 (DIN 259, BSPP)	G 1/16 – 1/8	341406
	G 1/4 – 3/8	341407
	G 1/2 – 3/4	341408
	G 1 – 2	341409
Pipe threads NPT tapered, right-hand Taper Pipe Thread ASME B1.20.1	NPT 1/16 – 1/8 HSS <sup>1)</sup>	341411
	NPT 1/4 – 3/8	341412
	NPT 1/2 – 3/4	341413
	NPT 1 – 2	341414
Pipe threads NPSM parallel, right-hand Straight Pipe Thread ASME B1.20.1	NPSM 1/8	341416
	NPSM 1/4 – 3/8	341417
	NPSM 1/2 – 3/4 HSS <sup>1)</sup>	341418
	NPSM 1 – 2 HSS <sup>1)</sup>	341419
Conduit threads Pg DIN 40430	Pg 7	341466
	Pg 9	341467
	Pg 11	341468
	Pg 13.5	341469
	Pg 16	341470
	Pg 21	341471
	Pg 29	341472
	Pg 36	341473
	Pg 42	341474
	Pg 48	341475
Conduit threads M EN 60423	M 16 × 1.5	341493
	M 20 × 1.5	341494
	M 25 × 1.5	341495
	M 32 × 1.5	341496
	M 40 × 1.5	341497
	M 50 × 1.5	341498
	M 63 × 1.5	341499
Metric bolt threads M ISO 261 (DIN 13)	M 6	341426
	M 8	341427
	M 10	341428
	M 12	341429
	M 14	341430
	M 16	341431
	M 18	341432
	M 20	341433
	M 22	341434
	M 24	341435
	M 27	341436
	M 30	341437
	M 33	341438
	M 36	341439
	M 39	341440
	M 42	341441
	M 45	341442
	M 48	341443
	M 52	341444
	M 56 HSS <sup>1)</sup>	341445
M 60 HSS <sup>1)</sup>	341446	
Bolt threads UNC Unified Inch Screw Thread ASME B1.1	UNC 1/4 – 20 HSS <sup>1)</sup>	341476
	UNC 5/16 – 18	341477
	UNC 3/8 – 16 HSS <sup>1)</sup>	341478
	UNC 7/16 – 14	341479
	UNC 1/2 – 13 HSS <sup>1)</sup>	341480
	UNC 9/16 – 12	341481
	UNC 5/8 – 11 HSS <sup>1)</sup>	341482
	UNC 3/4 – 10 HSS <sup>1)</sup>	341483
	UNC 7/8 – 9 HSS <sup>1)</sup>	341484
	UNC 1 – 8 HSS <sup>1)</sup>	341485
	UNC 1 1/8 – 7	341486
	UNC 1 1/4 – 7 HSS <sup>1)</sup>	341487
	UNC 1 3/8 – 6	341488
	UNC 1 1/2 – 6 HSS <sup>1)</sup>	341489
	UNC 1 3/4 – 5	341490
UNC 2 – 4.5	341491	

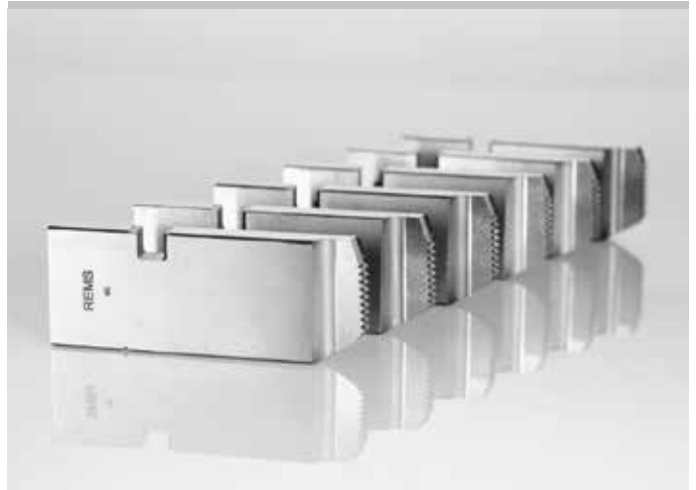

German Quality Product

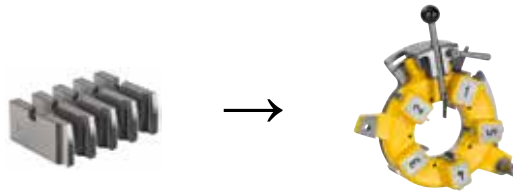

### For universal automatic die head 2 1/2 – 3"

Thread type	Size	Art.-No.
Pipe threads R tapered, right-hand ISO 7-1, EN 10226 (DIN 2999, BSPT)	R 2 1/2 – 3	381430
Pipe threads G parallel, right-hand ISO 228-1 (DIN 259, BSPP)	G 2 1/2 – 3 HSS <sup>1)</sup>	381431
Pipe threads NPT tapered, right-hand Taper Pipe Thread ASME B1.20.1	NPT 2 1/2 – 3 HSS <sup>1)</sup>	381432
Pipe threads NPSM parallel, right-hand Straight Pipe Thread ASME B1.20.1	NPSM 2 1/2 – 3 HSS <sup>1)</sup>	381433

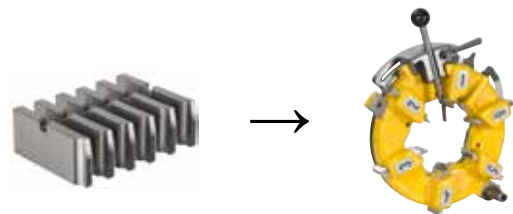

### For universal automatic die head 2 1/2 – 4"

Thread type	Size	Art.-No.
Pipe threads R tapered, right-hand ISO 7-1, EN 10226 (DIN 2999, BSPT)	R 2 1/2 – 4	381401
Pipe threads G parallel, right-hand ISO 228-1 (DIN 259, BSPP)	G 2 1/2 – 4 HSS <sup>1)</sup>	381405
Pipe threads NPT tapered, right-hand Taper Pipe Thread ASME B1.20.1	NPT 2 1/2 – 4 HSS <sup>1)</sup>	381410
Pipe threads NPSM parallel, right-hand Straight Pipe Thread ASME B1.20.1	NPSM 2 1/2 – 4 HSS <sup>1)</sup>	381415



**REMS**  
Unimat 77

**REMS**  
Unimat 75

Semi-automatic high-performance machine for efficient cutting of bolt and pipe threads. For industry, metalworking, installation.

Bolt threads	6 – 72 mm 1/4 – 2 3/4"	
Pipe threads	1/16 – 2 1/2", 16 – 63 mm	
Tolerance class corresponding to ISO 261 (DIN 13)	"medium" (6 g)	
Thread length	≤ Ø 30 mm	unlimited
	≤ Ø 72 mm	≤ 200 mm
Chamfering	Range	7 – 62 mm
	Chamfered Ø	≥ 7 mm
	Maximum chamfer	7 mm
	Chamfer angle	45°
Peeling	Range	7 – 62 mm
	Peeled Ø	≥ 7 mm

Thread types see page 44.

**REMS Unimat 75 – high efficiency. Tangential-chaser-threading-system. Large threading range. Fast working, short resetting time. For single and series production. Low hourly rate for the machine. Simple operation. Relieves expensive turning machines and specialists.**

### Operating principle

Stationary material – rotating die head.

### Design

Compact, rugged design for continuous use. Die head with regrindable tangential chasers in self centering holder system. After start-cutting with feed lever and rack mechanism self feeding action of die head (no guide thread). Welded, sturdy machine stand with large oil compartment and removeable chip drawer.

### Drive

Indestructible planetary gear with annulus gear for long threads up to Ø 30 mm. Proven and powerful pole-reversible three-phase motor, specially designed for threading, with hollow shaft, 2000/2300 W. Overload protection. Reverse switch for cutting right and left-hand threads. High operating speed, 2 spindle speeds 70 and 35 rpm.

### Clamping device

Self-centering universal vice for the complete range with specially toothed and hardened clamping jaws. Choice of manual or hydraulic clamping with operation by foot switch (working pressure 6 bar).

### Special clamping jaws

For drawn material, stud bolts, hex screws and pipe nipples, as accessory.

### Automatic lubrication and cooling

Robust, proven oil pump with high pumping volume. Ample oil volume ensures longer service life of chasers, gear and motor.

### Universal automatic die head

Only **one** universal automatic die head for all threads. Fine adjustment of thread diameter with spindle and scale. Die head closes automatically and opens automatically when the required thread length is reached. After starting the thread via feed lever and rack the chaser-system initiates an automatic feed-forward of the die head. All threads can be cut in a single pass. Copying unit for tapered threads. Instead of changing the dies, additional quick-change die heads ensure shorter resetting time.

### Chasers

The proven regrindable REMS tangential chasers with precise cutting geometry ensure an excellent start-cutting performance and clean threads. Tool steel chasers made of special hardened steel for material < 500 N/mm<sup>2</sup> (MPa). HSS chasers for hard-to-machine material ≥ 500 N/mm<sup>2</sup> (MPa). The chasers sit in a special holder system. Chasers and holders together form a threading set.

### Thread cutting on rebar

Special chaser dies M with additional, ground cut for cutting threads on rebar in a single pass. Driven by REMS Unimat 75 with oil-hydraulic/pneumatic vice, for high clamping pressure.



German Quality Product

Machining examples



Info



### Thread-cutting oil

REMS Sanitol and REMS Spezial (page 49). Specially developed for threading. High cooling and lubricating effect. Essential for clean threads and longer service life of dies, tools and machines.

### Nipple-threading

Efficient with special clamping jaws  $\frac{1}{16}$ – $1\frac{1}{4}$ " or with the automatic internal clamping REMS Nippelfix  $\frac{1}{2}$ – $2\frac{1}{2}$ " or with the manual internal clamping REMS Nippelspanner  $\frac{3}{8}$ – $2$ " (page 48).



### Supply format

**REMS Unimat 75 Basic.** Semi-automatic threading machine for bolt threads 6–72 mm,  $\frac{1}{4}$ – $2\frac{3}{4}$ ", pipe threads  $\frac{1}{16}$ – $2\frac{1}{2}$ ", 16–63 mm. Machine on stand. Pole-reversible 3~ induction motor with hollow shaft, 400 V, 50 Hz, 2000/2300 W, right and left-hand rotation. Die head speed 70 and 35 rpm. Self-centering universal chuck for the complete clamping range, choice of manual or oil-hydraulic/pneumatic operation. Automatic lubrication and cooling. 1 universal automatic die head for all threads, opens and closes automatically. Without threading sets, without closing lever. Electric locking system of safety cover. Adjustment gauge. Wrench. In transport case.

Description	Version	Art.-No.
<b>REMS Unimat 75 Basic mS</b>	manual clamping device	750003
<b>REMS Unimat 75 Basic pS</b>	oil-hydraulic/pneumatic vice clamping device	750004

Other voltages on request.

### Accessories

Description	Art.-No.
<b>Chasers and holders (threading sets) and chasers</b> see page 44.	
<b>Universal automatic die head</b> , without threading sets, without closing lever	751000
<b>Closing lever</b> for closing and opening the chasers	
<b>R</b> for taper pipe threads, right-hand	751040
<b>R-L</b> for taper pipe threads, left-hand	751050
<b>G</b> for cylindrical pipe threads, right-hand	751060
<b>G-L</b> for cylindrical pipe threads, left-hand	751070
<b>M</b> for all bolt threads, right-hand	751080
<b>M-L</b> for all bolt threads, left-hand	751090
<b>Chamfering/peeling die head 45°, Ø 7–62 mm</b> , with chamfering/peeling chasers 45°, Ø 7–62 mm, HSS, with holder	751100
<b>Chamfering/peeling die head 45°, Ø 7–62 mm</b> , without threading sets	751102
<b>Chamfering/peeling chasers 45°, Ø 7–46 mm</b> , HSS, with holder	751096
<b>Chamfering/peeling chasers 45°, Ø 40–62 mm</b> , HSS, with holder	751098
<b>Chamfering/peeling chasers 45°, Ø 7–62 mm</b> , pack of 4, with holder	751097
<b>Special clamping jaws, pair</b> , for drawn material, stud bolts and hex screws. Workpiece length protrude from vice without thread, minimum 15 mm, Ø 6–42 mm	753240
<b>Thread-cutting oil</b> see page 49.	
<b>Nipple holder</b> see page 48.	
<b>REMS Herkules material supports</b> , see page 107.	





German Quality Product

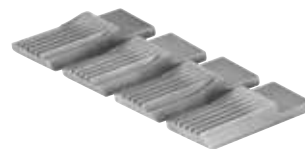

German Quality Product

### Chasers and holders (threading set)

The proven regrindable REMS tangential chasers with precise cutting geometry ensure an excellent start-cutting performance and clean threads. Tool steel chasers made of special hardened steel for material < 500 N/mm<sup>2</sup> (MPa). HSS chasers for hard-to-machine material ≥ 500 N/mm<sup>2</sup> (MPa). The chasers sit in a special holder system. Chasers and holders together form a threading set.

Thread type	Size	Art.-No.
Pipe threads R tapered, right-hand ISO 7-1, EN 10226 (DIN 2999, BSPT)	R 1/16 - 1/8	759250
	R 1/4 - 3/8	759251
	R 1/2 - 3/4	759252
	R 1 - 2	759253
	R 2 1/2	759254
Pipe threads G parallel, right-hand ISO 228-1 (DIN 259, BSPP)	G 1/16 - 1/8	759255
	G 1/4 - 3/8 HSS <sup>1)</sup>	759256
	G 1/2 - 3/4 HSS <sup>1)</sup>	759257
	G 1 - 2 HSS <sup>1)</sup>	759258
	G 2 1/2 HSS <sup>1)</sup>	759259
Pipe threads NPT tapered, right-hand Taper Pipe Thread ASME B1. 20.1	NPT 1/16 - 1/8	759360
	NPT 1/4 - 3/8 HSS <sup>1)</sup>	759361
	NPT 1/2 - 3/4 HSS <sup>1)</sup>	759362
	NPT 1 - 2 HSS <sup>1)</sup>	759363
	NPT 2 1/2 HSS <sup>1)</sup>	759364
Pipe threads NPSM parallel, right-hand Straight Pipe Thread ASME B1. 20.1	NPSM 1/16 - 1/8	759365
	NPSM 1/4 - 3/8	759366
	NPSM 1/2 - 3/4 HSS <sup>1)</sup>	759367
	NPSM 1 - 2 HSS <sup>1)</sup>	759368
Conduit threads Pg DIN 40430	Pg 7	759260
	Pg 9 - 16	759261
	Pg 21 - 48	759262
Conduit threads M EN 60423	M 16 - 20 x 1.5	759263
	M 25 - 32 x 1.5	759264
	M 40 - 50 x 1.5	759265
	M 63 x 1.5 HSS <sup>1)</sup>	759330
Threads M for rebar ISO 261 (DIN 13)	M 14 - 16 HSS	759274
	M 18 - 22 HSS	759275
	M 24 - 27 HSS	759276
	M 30 - 33 HSS	759277
	M 36 - 39 HSS	759278
	M 42 - 45 HSS	759279
Metric bolt threads M ISO 261 (DIN 13)	M 6 HSS <sup>1)</sup>	759270
	M 8	759271
	M 10	759272
	M 12	759273
	M 14 - 16	759274
	M 18 - 22	759275
	M 24 - 27	759276
	M 30 - 33	759277
	M 36 - 39	759278
	M 42 - 45	759279
	M 48 - 52 HSS <sup>1)</sup>	759280
	M 56 - 60 HSS <sup>1)</sup>	759281
	M 64 - 72 HSS <sup>1)</sup>	759282
Bolt threads UNC Unified Inch Screw Thread ASME B1.1	UNC 1/4 - 20	759370
	UNC 5/16 - 18	759371
	UNC 3/8 - 16	759372
	UNC 7/16 - 14	759373
	UNC 1/2 - 13	759374
	UNC 9/16 - 12	759375
	UNC 5/8 - 11	759376
	UNC 3/4 - 10	759377
	UNC 7/8 - 9	759378
	UNC 1 - 8 HSS <sup>1)</sup>	759379
	UNC 1 1/8 - 7	759380
	UNC 1 3/8 - 6	759381
	UNC 1 3/4 - 5	759382
	UNC 2 - 2 1/4 - 4.5	759383
	UNC 2 1/2 - 2 3/4 - 4	759384

Dies for other threads (e.g. bicycle threads, fine threads, BSW) and HSS chaser dies for materials above 500 N/mm<sup>2</sup> (MPa) that are difficult to cut on request. Dies with HSS chaser dies with 50% surcharge on chaser dies. <sup>1)</sup> Some chasers only available in HSS. Threading sets for left-hand threads 50% extra charge on chasers.

### Chasers (set)

The proven regrindable REMS tangential chasers with precise cutting geometry ensure an excellent start-cutting performance and clean threads. Tool steel chasers made of special hardened steel for material < 500 N/mm<sup>2</sup> (MPa). HSS chasers for hard-to-machine material ≥ 500 N/mm<sup>2</sup> (MPa).

Thread type	Size	Art.-No.
Pipe threads R tapered, right-hand ISO 7-1, EN 10226 (DIN 2999, BSPT)	R 1/16 - 1/8	751501
	R 1/4 - 3/8	751502
	R 1/2 - 3/4	751503
	R 1 - 2 1/2	751504
Pipe threads G parallel, right-hand ISO 228-1 (DIN 259, BSPP)	G 1/16 - 1/8 HSS <sup>1)</sup>	751505
	G 1/4 - 3/8	751506
	G 1/2 - 3/4 HSS <sup>1)</sup>	751507
	G 1 - 2 1/2 HSS <sup>1)</sup>	751508
Pipe threads NPT tapered, right-hand Taper Pipe Thread ASME B1. 20.1	NPT 1/16 - 1/8	751544
	NPT 1/4 - 3/8 HSS <sup>1)</sup>	751545
	NPT 1/2 - 3/4 HSS <sup>1)</sup>	751546
	NPT 1 - 2 HSS <sup>1)</sup>	751547
Pipe threads NPSM parallel, right-hand Straight Pipe Thread ASME B1. 20.1	NPSM 1/16 - 1/8	751549
	NPSM 1/4 - 3/8	751550
	NPSM 1/2 - 3/4 HSS <sup>1)</sup>	751551
	NPSM 1 - 2	751552
Conduit threads Pg DIN 40430	Pg 7	751509
	Pg 9 - 16	751510
	Pg 21 - 48	751511
Conduit threads M EN 60423	M 16 - 63 x 1.5 (M 10)	751518
Threads M for rebar ISO 261 (DIN 13)	M 14 - 16 HSS	751520
	M 18 - 22 HSS	751521
	M 24 - 27 HSS	751522
	M 30 - 33 HSS	751523
	M 36 - 39 HSS	751524
	M 42 - 45 HSS	751525
Metric bolt threads M ISO 261 (DIN 13)	M 6	751516
	M 8	751517
	M 10 (M 16 - 63 x 1.5)	751518
	M 12	751519
	M 14 - 16	751520
	M 18 - 22	751521
	M 24 - 27	751522
	M 30 - 33	751523
	M 36 - 39	751524
	M 42 - 45	751525
	M 48 - 52	751526
	M 56 - 60	751527
	M 64 - 72	751528
Bolt threads UNC Unified Inch Screw Thread ASME B1.1	UNC 1/4 - 20	751557
	UNC 5/16 - 18	751558
	UNC 3/8 - 16	751559
	UNC 7/16 - 14	751560
	UNC 1/2 - 13	751561
	UNC 9/16 - 12	751562
	UNC 5/8 - 11	751563
	UNC 3/4 - 10	751564
	UNC 7/8 - 9	751565
	UNC 1 - 8 HSS <sup>1)</sup>	751566
	UNC 1 1/8 - 7	751567
	UNC 1 3/8 - 6	751568
	UNC 1 3/4 - 5	751569
UNC 2 - 2 1/4 - 4.5	751570	
UNC 2 1/2 - 2 3/4 - 4	751571	

Chaser dies for other threads (e.g. bicycle threads, fine threads, BSW) and HSS chaser dies for materials above 500 N/mm<sup>2</sup> (MPa) that are difficult to cut on request. HSS chaser dies with 50% surcharge. <sup>1)</sup> Some chasers only available in HSS. Chasers for left-hand threads 50% extra charge.

# Thread tables

## Taper Pipe Threads

Whitworth Pipe Thread ISO 7-1, EN 10226 (DIN 2999, BSPT) External thread taper 1:16 Flank angle 55°		
Nominal Size <b>R</b> <b>BSPT</b>	Outside Ø of thread mm	T.P.I.
1/16	7.723	28
1/8	9.728	28
1/4	13.157	19
3/8	16.662	19
1/2	20.955	14
3/4	26.441	14
1	33.249	11
1 1/4	41.910	11
1 1/2	47.803	11
2	59.614	11
2 1/2	75.184	11
3	87.884	11
4	113.030	11

Standard Taper Pipe Thread NPT, ASME B 1.20.1 External thread taper 1:16 Flank angle 60°		
Nominal Size <b>NPT</b>	Outside Ø of thread mm	T.P.I.
1/16	7.938	27
1/8	10.287	27
1/4	13.716	18
3/8	17.145	18
1/2	21.336	14
3/4	26.670	14
1	33.401	11.5
1 1/4	42.164	11.5
1 1/2	48.260	11.5
2	60.325	11.5
2 1/2	73.025	8
3	88.900	8
3 1/2	101.600	8
4	114.300	8

Whitworth Pipe Thread ISO 228-1 (DIN 259, BSPP) External thread parallel Flank angle 55°		
Nominal Size <b>G</b> <b>BSPP</b>	Outside Ø of thread mm	T.P.I.
1/16	7.723	28
1/8	9.728	28
1/4	13.157	19
3/8	16.662	19
1/2	20.955	14
3/4	26.441	14
1	33.249	11
1 1/4	41.910	11
1 1/2	47.803	11
2	59.614	11
2 1/2	75.184	11
3	87.884	11
3 1/2	100.330	11
4	113.030	11

Straight Pipe Thread for Fixtures NPSM, ASME B 1.20.1 External thread parallel Flank angle 60°		
Nominal Size <b>NPSM</b>	Outside Ø of thread mm	T.P.I.
1/8	10.083	27
1/4	13.360	18
3/8	16.815	18
1/2	20.904	14
3/4	26.264	14
1	32.842	11.5
1 1/4	41.605	11.5
1 1/2	47.676	11.5
2	59.715	11.5
2 1/2	72.161	8
3	88.062	8
3 1/2	100.787	8
4	113.436	8

## Metric Bolt Thread

Metric ISO Thread ISO 261 (DIN 13) External thread Flank angle 60°		
Nominal Size <b>M</b>	Outside Ø of thread mm	Pitch mm
6	5.974	1
8	7.972	1.25
10	9.968	1.5
12	11.966	1.75
14	13.962	2
16	15.962	2
18	17.958	2.5
20	19.958	2.5
22	21.958	2.5
24	23.952	3
27	26.952	3
30	29.947	3.5
33	32.947	3.5
36	35.940	4
39	38.940	4
42	41.937	4.5
45	44.937	4.5
48	47.929	5
52	51.929	5
56	55.925	5.5
60	59.925	5.5
64	63.920	6
68	67.920	6
72	71.920	6

## American and British Bolt Threads

Unified Inch Screw Thread UNC, ASME B 1.1 External thread Flank angle 60°		
Nominal Size <b>UNC</b>	Outside Ø of thread mm	T.P.I.
1/4	6.322	20
5/16	7.907	18
3/8	9.491	16
7/16	11.076	14
1/2	12.661	13
9/16	14.246	12
5/8	15.834	11
3/4	19.004	10
7/8	22.176	9
1	25.349	8
1 1/8	28.519	7
1 1/4	31.694	7
1 3/8	34.864	6
1 1/2	38.039	6
1 3/4	44.381	5
2	50.726	4.5
2 1/4	57.076	4.5
2 1/2	63.421	4
2 3/4	69.768	4

British Standard Parallel Screw Thread of Whitworth Form <b>B.S.W.</b> BS 84 (obsolete): External thread Flank angle 55°		
Nominal Size <b>BSW</b>	Outside Ø of thread mm	T.P.I.
1/4	6.350	20
5/16	7.937	18
3/8	9.525	16
7/16	11.112	14
1/2	12.700	12
5/8	15.875	11
3/4	19.050	10
7/8	22.225	9
1	25.400	8
1 1/8	28.575	7
1 1/4	31.750	7
1 1/2	38.100	6
1 3/4	44.450	5
2	50.800	4.5
2 1/4	57.150	4
2 1/2	63.500	4
2 3/4	69.850	3.5

## Threads for Electric Conduit

Conduit Thread DIN 40 430 External thread parallel Flank angle 80°		
Nominal Size <b>Pg</b>	Outside Ø of thread mm	T.P.I.
7	12.5	20
9	15.2	18
11	18.6	18
13.5	20.4	18
16	22.5	18
21	28.3	16
29	37	16
36	47	16
42	54	16
48	59.3	16

Conduit Thread EN 60423 External thread parallel Flank angle 60°		
Nominal Size <b>M</b>	Outside Ø of thread mm	Pitch mm
16	15.968	1.5
20	19.968	1.5
25	24.968	1.5
32	31.968	1.5
40	39.968	1.5
50	49.968	1.5
63	62.968	1.5

Outside diameter of thread is always the maximum diameter, for taper pipe threads this is measured at the scale line.



Semi-automatic high-performance machine for efficient cutting of pipe threads. For industry, metalworking, installation.

Pipe threads	¼ – 4"
Thread length	≤ 120 mm

**REMS Unimat 77 – pipe threads up to 4".**

**Tangential-chaser-threading-system.**

**Fast working, short resetting time.**

**For single and series production.**

### Operating principle

Stationary material – rotating die head.

### Design

Compact, rugged design for continuous use. Die head with regrindable tangential chasers in self centering holder system. After start-cutting with feed lever and rack mechanism self feeding action of die head (no guide thread). Welded, sturdy machine stand with large oil compartment and removeable chip drawer.

### Drive

Robust worm gear and 2-stage spur gear. Proven and powerful pole-reversible three-phase motor, specially designed for threading. 2000/2300 W. Overload protection. Reverse switch for cutting right and left-hand threads. 4 spindle speeds 50, 25, 16, 8 rpm.

### Clamping device

Self-centering universal vice for the complete range of pipe with specially toothed and hardened clamping jaws (¼ – ¾", 1 – 4"). Choice of manual or hydraulic clamping with operation by foot switch (working pressure 6 bar).

### Automatic lubrication and cooling

Robust, proven oil pump with high pumping volume. Ample oil volume ensures longer life of chasers, gear and motor.

### Universal automatic die head

Only **one** universal automatic die head for all threads. Fine adjustment of thread diameter with spindle and scale. Die head closes automatically and opens automatically when the required thread length is reached. After starting the thread via feed lever and rack the chaser-system initiates an automatic feed-forward of the die head. All threads can be cut in a single pass. Copying unit for tapered threads. Instead of changing the dies, additional quick-change die heads ensure shorter resetting time.

### Chasers

The proven regrindable REMS tangential chasers with precise cutting geometry ensure an excellent start-cutting performance and clean threads. Tool steel chasers made of special hardened steel for material < 500 N/mm<sup>2</sup> (MPa). HSS chasers for hard-to-machine material ≥ 500 N/mm<sup>2</sup> (MPa). The chasers sit in a special holder system. Chasers and holders together form a threading set.

### Thread-cutting oil

REMS Sanitol and REMS Spezial (page 49). Specially developed for threading. High cooling and lubricating effect. Essential for clean threads and longer service life of dies, tools and machines.

### Nipple-threading

Efficient with the automatic internal clamping REMS Nippelfix ½ – 4" or with the manual internal clamping REMS Nippelspanner ¾ – 2" (page 48).



German Quality Product

Machining examples



Info





### Supply format

**REMS Unimat 77 Basic.** Semi-automatic threading machine for pipe threads  $\frac{1}{4}$  – 4". Machine on stand. Pole-reversible 3~ induction motor, 400 V, 50 Hz, 2000/2300 W, right and left-hand rotation. Die head speed 50, 25, 16, 8 rpm. Universal vice with clamping jaws 1 – 4", choice of manual or hydraulic/pneumatic operation. Automatic lubrication. 1 universal automatic die head for all threads, opens and closes automatically. Without threading sets, without closing lever. Electrical locking system of safety cover. Adjustment gauge. Wrench. In transport case.

Description	Version	Art.-No.
<b>REMS Unimat 77 Basic mS</b>	manual clamping device	770003
<b>REMS Unimat 77 Basic pS</b>	Oil-hydraulic/pneumatic vice clamping device	770004

Other voltages on request.

### Accessories

#### Chasers and holders (threading set)

Thread type	Size	Art.-No.
Pipe threads R tapered, right-hand ISO 7-1 (EN 10226, DIN 2999, BSPT)	R $\frac{1}{4}$ – $\frac{3}{8}$	771110
	R $\frac{1}{2}$ – $\frac{3}{4}$	771120
	R 1 – 2	771130
	R 2 $\frac{1}{2}$ – 4	771140
Pipe threads G parallel, right-hand ISO 228-1 (DIN 259, BSPP)	G $\frac{1}{4}$ – $\frac{3}{8}$	771160
	G $\frac{1}{2}$ – $\frac{3}{4}$ HSS <sup>1)</sup>	771170
	G 1 – 2 HSS <sup>1)</sup>	771180
	G 2 $\frac{1}{2}$ – 4 HSS <sup>1)</sup>	771190
Pipe threads NPT tapered, right-hand Taper Pipe Thread ASME B1.20.1	NPT $\frac{1}{4}$ – $\frac{3}{8}$	771210
	NPT $\frac{1}{2}$ – $\frac{3}{4}$ HSS <sup>1)</sup>	771220
	NPT 1 – 2 HSS <sup>1)</sup>	771230
	NPT 2 $\frac{1}{2}$ – 4 HSS <sup>1)</sup>	771240
Pipe threads NPSM parallel, right-hand Straight Pipe Thread ASME B1.20.1	NPSM $\frac{1}{4}$ – $\frac{3}{8}$	771260
	NPSM $\frac{1}{2}$ – $\frac{3}{4}$ HSS <sup>1)</sup>	771270
	NPSM 1 – 2	771280

#### Chasers (set)

Thread type	Size	Art.-No.
Pipe threads R tapered, right-hand ISO 7-1 (EN 10226, DIN 2999, BSPT)	R $\frac{1}{4}$ – $\frac{3}{8}$	751502
	R $\frac{1}{2}$ – $\frac{3}{4}$	751503
	R 1 – 4	771136
Pipe threads G parallel, right-hand ISO 228-1 (DIN 259, BSPP)	G $\frac{1}{4}$ – $\frac{3}{8}$ HSS <sup>1)</sup>	751506
	G $\frac{1}{2}$ – $\frac{3}{4}$ HSS <sup>1)</sup>	751507
	G 1 – 4 HSS <sup>1)</sup>	771186
Pipe threads NPT tapered, right-hand Taper Pipe Thread ASME B1.20.1	NPT $\frac{1}{4}$ – $\frac{3}{8}$ HSS <sup>1)</sup>	751545
	NPT $\frac{1}{2}$ – $\frac{3}{4}$ HSS <sup>1)</sup>	751546
	NPT 1 – 2 HSS <sup>1)</sup>	751547
	NPT 2 $\frac{1}{2}$ – 4 HSS <sup>1)</sup>	771246
Pipe threads NPSM parallel, right-hand Straight Pipe Thread ASME B1.20.1	NPSM $\frac{1}{4}$ – $\frac{3}{8}$	751550
	NPSM $\frac{1}{2}$ – $\frac{3}{4}$ HSS <sup>1)</sup>	751551
	NPSM 1 – 2	751552

Dies and chaser dies for other threads and HSS chaser dies for materials above 500 N/mm<sup>2</sup> (MPa) that are difficult to cut on request. Dies and HSS chaser dies with 50% surcharge on chaser dies. <sup>1)</sup>Some threading sets and chasers only available in HSS. Threading sets and chasers for left-hand threads 50% extra charge.

Description	Art.-No.
<b>Universal automatic die head,</b> without threading sets, without closing lever	771000
<b>Closing lever</b> for closing and opening the chasers	
<b>R</b> for taper pipe threads, right-hand	751040
<b>R-L</b> for taper pipe threads, left-hand	751050
<b>G</b> for cylindrical pipe threads, right-hand	751060
<b>G-L</b> for cylindrical pipe threads, left-hand	751070
<b>Clamping jaws <math>\frac{1}{4}</math> – <math>\frac{3}{4}</math>" (pack of 2)</b>	773060

**Thread-cutting oil** see page 49.

**Nipple holder** see page 48.

**REMS Herkules material supports,** see page 107.



# REMS Nippelspanner

Accessories for threading machines and hand die stocks of all types and makes

Manual pipe nipple chuck for internal clamping of short pipe pieces. For universal use.

Nipples and double nipples in standard and special lengths 3/8 – 2"

## REMS Nippelspanner – efficient nipple-threading. Any length. Anywhere.

To be used universally for threading machines and for hand die stocks of all types and makes. For opening and non-opening die heads. Ideal accessory for REMS Amigo E, REMS Amigo, REMS Amigo 2, REMS Amigo 2 Compact, REMS Amigo 22V, REMS eva and other makes.

Ideal tool for using up short pipe pieces. Saves time and money.

Chucking and centering of pipe pieces by expanding of specially hardened spring steel segments.

Internal clamping, so no thread required for clamping.

### Supply format

**REMS Nippelspanner.** Manual pipe nipple chuck for internal clamping of short pipe pieces.

Description	Size	Art.-No.
<b>REMS Nippelspanner</b>	3/8"	110000
	1/2"	110100
	3/4"	110200
	1"	110300
	1 1/4"	110400
	1 1/2"	110500
	2"	110600

### Supply format

**REMS Nippelspanner Set.** Manual pipe nipple chuck for internal clamping of short pieces of pipe. In sturdy steel case.

Description	Art.-No.
<b>Set 1/2 + 3/4 + 1 + 1 1/4"</b>	110620
<b>Set 1/2 + 3/4 + 1 + 1 1/4 + 1 1/2 + 2"</b>	110621



German Quality Product



# REMS Nippelfix

Accessories for threading machines with opening die head

Automatic pipe nipple chuck for internal clamping of short pipe pieces.

Nipples and double nipples in standard and special lengths 1/2 – 4"

## REMS Nippelfix – efficient nipple-threading up to 4". Any length. Anywhere. Automatic internal clamping. Super fast and simple.

For threading machines with opening die head: Pipe turning machines, machines with rotating die head, threading devices.

Ideal tool for using up short pipe pieces. Saves time and money.

Automatic quick-chuck and centering of pipe piece. No tools.

Automatic release after completion of nipple. Production of nipples possible without taking the Nippelfix out of the clamping device.

Internal clamping, so no thread required for clamping.

Specially hardened and ground clamping jaws for fast and safe clamping.

### Supply format

**REMS Nippelfix.** Automatic pipe nipple chuck for internal clamping of short pipe pieces.

Description	Size	Art.-No.
<b>REMS Nippelfix</b>	1/2"	111000
	3/4"	111100
	1"	111200
	1 1/4"	111300
	1 1/2"	111400
	2"	111500
	2 1/2"	111700
	3"	111800
	4"	111900

### Supply format

**REMS Nippelfix Set.** Automatic pipe nipple chuck for internal clamping of short pieces of pipe. In sturdy steel case.

Description	Art.-No.
<b>Set 1/2 + 3/4 + 1 + 1 1/4"</b>	111620
<b>Set 1/2 + 3/4 + 1 + 1 1/4 + 1 1/2 + 2"</b>	111621



German Quality Product



# REMS Spezial

Thread-cutting oil

High-alloyed mineral oil based thread-cutting oil.  
For all materials.

For drinking water supplies, comply with local regulations! Mineral oil based thread cutting materials are not permitted for drinking water pipes in AUT, CHE, DEU, DNK and FRA for example.

**REMS Spezial – high-alloyed mineral based thread-cutting oil, can be washed out with water. High lubricating and cooling effect.**

Specially developed for threading. High lubricating and cooling effect. Essential for clean threads, long service life of dies, tools and machines. Can be washed out with water, approved by experts. Also well suited as a cooling lubricant for sawing metals. REMS Spezial spray without CFC's, so ozone-harmless. REMS Spezial squirt bottle without propellants. Refillable.



German Quality Product

## Supply format

**REMS Spezial.** High-alloyed mineral based thread-cutting oil.

Description	Packing	Art.-No.
<b>REMS Spezial</b>	5 l can	140100
	10 l can	140101
	50 l barrel	140103
	600 ml spray	140105
	500 ml squirt bottle	140106

# REMS Sanitol

Thread-cutting oil

Synthetic, mineral oil-free thread-cutting oil.  
Specially for drinking water supplies. For all materials.

**REMS Sanitol – mineral oil-free, ethanol-free. Completely water soluble. High lubricating and cooling effect.**

Developed especially for drinking water pipes but also excellently suitable for universal thread cutting. High lubricating and cooling effect. Essential for clean threads, long service life of dies, tools and machines.

Completely water soluble. Mineral oil-free, ethanol-free. Therefore no negative influence on the drinking water in terms of appearance, smell and taste.

Red in colour for flushing control. Perfect corrosion protector.

Viscosity at -10°C: ≤ 250 mPa s (cP). Pumpable to -28°C.

Also well suited as a cooling lubricant for sawing metals.

REMS Sanitol spray without CFC's, so ozone-harmless.

REMS Sanitol squirt bottle without propellants. Refillable.



German Quality Product

## Supply format

**REMS Sanitol.** Synthetic, mineral oil free thread-cutting oil specially for drinking water supplies and for universal use.

Description	Packing	Art.-No.
<b>REMS Sanitol</b>	5 l can	140110
	50 l barrel	140113
	600 ml spray	140115
	500 ml squirt bottle	140116



DW-0201 AS2032



W1.303



7808-649

# REMS roll grooving attachment

Roll grooving attachment

Robust, compact roll grooving attachment with oil hydraulic forward feed for grooving pipes of pipe coupling systems. For installation, sprinkler lines, commercial heating, industry and mining. For job site and workshop.

Steel pipes DN 25 – 300  
1 – 12"  
s ≤ 7.2 mm

Stainless steel pipes, copper, aluminium, PVC pipes

**REMS roll grooving attachment – compact – universal. Oil hydraulic pressure cylinder for powerful in-feed of pressure roller.**

## Design

Compact, job site-proven. Robust metal housing for tough use. Handy, easy to transport, only 26 kg. Oil hydraulic pressure cylinder for powerful in-feed of pressure roller. Pressure build-up with hydraulic hand pump. Individually adjustable groove-depth-stop with fine adjustment, for automatic limitation of groove depth. Built-in ring gauge for automatic groove-depth-stop.

## Grooving rollers

The proven REMS grooving rollers with perfectly size-adjusted pressure rollers and counterpressure rollers with well gripping axial knurls guarantee a secure rotation of the pipe and precise grooving. Grooving rollers machined from hardened special steel ensure extremely long service life. 3 pairs of groove rollers (pressure roller, counter-pressure roller) for the whole working range DN 25 – 300, 1 – 12", easy change. Grooving rollers Cu (pressure roller, counterpressure roller) for copper pipe 54 – 159 mm. Groove rollers INOX (pressure roller made of stainless steel, counter-pressure roller made of toughened, specially hardened steel, nickel-plated) for stainless steel pipes 1 – 1½", 2 – 6" and 8 – 12". Grooving rollers for aluminium, PVC pipes on request.

## Drive

Only one roll grooving device for REMS Amigo, REMS Amigo 2, REMS Amigo 2 Compact, REMS Tornado and REMS Magnum. Fast, simple assembly. 3-face drive shaft of roll grooving attachment for secure clamping and optimum power transmission. Roll grooving attachments for threading machines of other makes, adjusted to support arm distance, diameter of support arm and spindle axis of the corresponding drive machine, on request.



German Quality Product



Info



## Supply format

**REMS roll grooving attachment.** Roll grooving attachment for grooving pipes of pipe coupling systems DN 25 – 300, 1 – 12". Roll grooving attachment, hydraulic hand pump, built-in ring gauge for automatic groove-depth-stop, 1 pair of groove rollers (pressure roller, counter-pressure roller) 2 – 6", Allen key. For REMS Amigo, REMS Amigo 2, REMS Amigo 2 Compact, REMS Tornado and REMS Magnum or for other thread cutting machine makes. In a carton.

Description	fit onto	Art.-No.
<b>REMS roll grooving attachment</b>	REMS Amigo/ Amigo 2 Compact <sup>1)</sup> REMS Amigo 2 <sup>1)</sup> REMS Tornado <sup>2)</sup> REMS Magnum <sup>2)</sup>	347000
<b>Roll grooving attachment R 300</b>	Ridgid 300	347001

<sup>1)</sup> Conversion kit Amigo/Amigo 2/Amigo 2 Compact (Art. No. 347007) required.

Can be used for roll grooving devices manufactured from 2014 onwards.

<sup>2)</sup> Can only be used for roll grooving up to DN 200, 8" on T versions.

Roll grooving attachments for other makes on request.

## Accessories

Description	Art.-No.
<b>Grooving rollers 1 – 1½"</b> (pair), for steel pipes	347030
<b>Grooving rollers INOX 1 – 1½"</b> (pair), for stainless steel pipes	347053
<b>Grooving rollers 2 – 6"</b> (pair), for steel pipes	347035
<b>Grooving rollers INOX 2 – 6"</b> (pair), for stainless steel pipes	347046
<b>Grooving rollers 8 – 12"</b> (set), for steel pipes	347040
<b>Grooving rollers INOX 8 – 12"</b> (pair), for stainless steel pipes	347047
<b>Grooving rollers Cu 54 – 159</b> (pair) for Cu pipes	347034
<b>Conversion kit Amigo / Amigo 2 / Amigo 2 Compact / Amigo 22V</b>	347007

REMS Herkules material supports, see page 107.



Powerful roll grooving machine for fast, economical grooving of pipes for pipe coupling systems. For installation, sprinkler lines, commercial heating, industry and mining. For job site and workshop.

Steel pipes DN 25 – 300  
1 – 12"  
s ≤ 7.2 mm

Stainless steel pipes, copper, aluminium, PVC pipes

**REMS Collum – electrical roll grooving up to 12".**  
Fast and economical feed of the pressure roller with oil-hydraulic pressure cylinder.

### Design

Robust, compact construction suitable for building sites. Favourable dimensions, favourable weight, roll grooving device with drive machine only 31 kg. For work bench. Stand or wheel stand as an accessory, for easy transport, optimum working height and stable positioning.

### Drive

Fast and powerful, e.g. roll grooving of 6" steel pipe with REMS Collum in just 52 s. Sturdy, compact gear, maintenance-free. Robust, powerful 1200 W universal motor (REMS Collum and REMS Collum 2 Compact) or 1700 W universal motor (REMS Collum 2) for intensive use at large dimensions. Safety switch. Foot switch with coupling for ergonomic working as an accessory.

### Roll grooving attachment

Compact, job site-proven. Robust metal housing for tough use. Handy, easy to transport, only 26 kg. Oil hydraulic pressure cylinder for powerful in-feed of pressure roller. Pressure build-up with hydraulic hand pump. Built-in ring gauge for automatic groove-depth-stop.

### Grooving rollers

The proven REMS grooving rollers with perfectly size-adjusted pressure rollers and counterpressure rollers with well gripping axial knurls guarantee a secure rotation of the pipe and precise grooving. Grooving rollers machined from hardened special steel ensure extremely long service life. 3 pairs of groove rollers (pressure roller, counter-pressure roller) for the whole working range DN 25 – 300, 1 – 12", easy change. Grooving rollers Cu (pressure roller, counterpressure roller) for copper pipe 54 – 159 mm. Groove rollers INOX (pressure roller made of stainless steel, counter-pressure roller made of toughened, specially hardened steel, nickel-plated) for stainless steel pipes 1 – 1½", 2 – 6" and 8 – 12". Grooving rollers for aluminium, PVC pipes on request.

### Material support

Extra sturdy REMS Herkules XL 12" material support for roll grooving of pipes up to 12" (page 107).



German Quality Product



Info



Wheel stand (Accessory)

Herkules 3B (Accessory)

### Supply format

**REMS Collum.** Roll grooving attachment for grooving pipes of pipe coupling systems DN 25 – 300, 1 – 12". Roll grooving attachment, hydraulic hand pump, built-in ring gauge for automatic groove-depth-stop, 1 pair of groove rollers (pressure roller, counter-pressure roller) 2 – 6", Allen key. Choice of 3 drive units, with maintenance-free gear, powerful universal motor, safety switch. For workbench, stand or wheel stand. In a carton.

Description	Version	Art.-No.
<b>Collum</b>	Universal motor 230 V, 50 – 60 Hz, 1200 W, overload protection. 29 min <sup>-1</sup>	347006
<b>Collum 2</b>	Universal motor 230 V, 50 – 60 Hz, 1700 W. 28 min <sup>-1</sup>	347008
<b>Collum 2 Compact</b>	Universal motor 230 V, 50 – 60 Hz, 1200 W, overload protection. 26 min <sup>-1</sup>	347009

Other voltages on request.

### Accessories

Description	Art.-No.
<b>Stand</b>	849315
<b>Wheel stand</b>	849310
<b>Foot switch with coupling</b>	347010

**REMS Herkules** material supports, see page 107.

**Grooving rollers** and other accessories, see page 50.



Powerful, mobile, cordless roll grooving machine for fast, economical grooving of pipes for pipe coupling systems. For installation, sprinkler lines, commercial heating, industry and mining. For job site and workshop. Li-Ion 22V Technology. For battery and corded operation.

Steel pipes	DN 25 – 300 1 – 12" s ≤ 7.2 mm
-------------	--------------------------------------

Stainless steel pipes, copper, aluminium, PVC pipes

**REMS Collum 22 V – electrical roll grooving up to 12".**  
**Mobile, fast, economical. Feed of the pressure roller with oil-hydraulic pressure cylinder. Li-Ion 21.6 V, 9.0 Ah battery, for approx. 23 DN 100/4" grooves with one battery charge\*.**

### Design

Compact, robust, building site-compatible, mobile. Convenient dimensions, comfortable weight, cordless roll grooving machine with drive unit just 34 kg. Practical D-shaped handle with soft grip. Machine status check with overload protection of the drive unit against too high currents, with overheating protection by motor temperature monitoring (NTC), with electronic battery charging status check by a 2-coloured green/red LED. For work bench. Stand or wheel stand as an accessory, for easy transport, optimum working height and stable positioning.

### Drive

Powerful and fast, e.g. roll grooving of 4" steel pipe in just 77 s. Solid, maintenance-free gear. Powerful battery motor 21.6 V, with high power reserve, 500 W output, for intensive use with large dimensions. High grooving speed 27 – 20 rpm. Safety tip switch.

### Battery or mains operation

Li-Ion 22V Technology. Highly resistant Li-Ion 21.6 V batteries with 9.0 Ah capacity for long service life. Light and powerful, for approx. 23 DN 100/4" grooves with one battery charge\*. Graduated charging status check by coloured LEDs. Operating temperature range –10 to +60 °C. No memory effect for maximum battery power. Rapid charger 100 – 240 V, 90 W. Rapid charger 100 – 240 V, 290 W, for shorter charging times, as accessory. Voltage supply 220 – 240 V/21.6 V, 40 A output, for mains operation instead of Li-Ion battery 21.6 V, as accessory.

### Roll grooving attachment

Compact, job site-proven. Robust metal housing for tough use. Handy, easy to transport, only 26 kg. Oil hydraulic pressure cylinder for powerful in-feed of pressure roller. Pressure build-up with hydraulic hand pump. Built-in ring gauge for automatic groove-depth-stop.

### Grooving rollers

The proven REMS grooving rollers with perfectly size-adjusted pressure rollers and counterpressure rollers with well gripping axial knurls guarantee a secure rotation of the pipe and precise grooving. Grooving rollers machined from hardened special steel ensure extremely long service life. 3 pairs of groove rollers (pressure roller, counter-pressure roller) for the whole working range DN 25 – 300, 1 – 12", easy change. Grooving rollers Cu (pressure roller, counterpressure roller) for copper pipe 54 – 159 mm. Groove rollers INOX (pressure roller made of stainless steel, counter-pressure roller made of toughened, specially hardened steel, nickel-plated) for stainless steel pipes 1 – 1½", 2 – 6" and 8 – 12". Grooving rollers for aluminium, PVC pipes on request.

### Material support

Extra sturdy REMS Herkules XL 12" material support for roll grooving of pipes up to 12" (page 107).



German Quality Product



Info





Wheel stand (Accessory)

Herkules 3B (Accessory)



Stand (Accessory)

Herkules XL 12" (Accessory)



### Supply format

**REMS Collum 22V.** Cordless roll grooving machine for grooving pipes for DN 25–300, 1–12" pipe coupling systems. Roll grooving attachment, hydraulic hand pump, built-in ring gauge for automatic groove-depth-stop, 1 pair of groove rollers (pressure roller, counter-pressure roller) 2–6", Allen key. Drive unit with maintenance-free gear, powerful battery motor 21.6V, 500 W. Safety switch. Right and left-hand rotation, machine status check with overload protection, temperature monitoring, battery charging status check. Universal support. Li-Ion 21.6V, 9.0Ah battery, 100–240V, 50–60 Hz, 90W rapid charger. For workbench, stand or wheel stand. In a carton.

	Art.-No.
	347005

Other voltages on request.

### Accessories

Description	Art.-No.
<b>REMS Amigo 22V drive unit, without battery</b>	530004
<b>Battery Li-Ion 21.6V, 9.0Ah</b>	571583
<b>Rapid charger 100–240V, 50–60 Hz, 90W</b>	571585
<b>Rapid charger 100–240V, 50–60 Hz, 290W</b>	571587
<b>Voltage supply 220–240V/21.6V, 50–60 Hz, 40A, for mains operation instead of battery Li-Ion 21.6V</b>	571578
<b>Stand</b>	849315
<b>Wheel stand</b>	849310

**REMS Herkules** material supports, see page 107.

**Grooving rollers** and other accessories, see page 50.

**REMS Lumen 2800 22V**, cordless LED flood light, see page 111



\* Ambient temperature approx. 20°C.



Robust, compact high performance machine with roll grooving attachment for pipe grooving of pipe coupling systems. For installation, sprinkler lines, commercial heating lines, industry and mining.  
For job site and workshop.

Steel pipes	DN 25 – 300 1 – 12" s ≤ 7.2 mm
-------------	--------------------------------------

Stainless steel pipes, copper, aluminium, PVC pipes

Pipe threads 1/8" – 2", 16 – 63 mm, bolt threads 6 – 60 mm, 1/4" – 2", with conversion kit.

**REMS Magnum RG – the compact up to 12". Immensely powerful and extremely fast. Feed of the pressure roller with oil-hydraulic pressure cylinder.**

### Design

Robust, compact, job site-proven design. Favorable size and weight, e.g. REMS Magnum 2000 RG-T only 68 kg. Tool support. For workbench. Stand, collapsible wheel stand or wheel stand with material shelf, as an accessory, for easy transport, optimum working height and stable positioning.

### Drive

Immensely powerful and fast, e.g. roll grooving of 6" steel pipe with REMS Magnum 2010 RG-T in just 40 s. Completely maintenance-free gear which runs in a sealed oil bath. Choice of 3 powerful motors (see REMS Magnum page 34). Operator-friendly safety foot switch with emergency-stop, 2-step, can be loaded with the full body weight during operation.

### Roll grooving attachment

Compact, job site-proven. Robust metal housing for tough use. Handy, easy to transport, only 26 kg. Oil hydraulic pressure cylinder for powerful in-feed of pressure roller. Pressure build-up with hydraulic hand pump. Built-in ring gauge for automatic groove-depth-stop.

### Grooving rollers

The proven REMS grooving rollers with perfectly size-adjusted pressure rollers and counterpressure rollers with well gripping axial knurls guarantee a secure rotation of the pipe and precise grooving. Grooving rollers machined from hardened special steel ensure extremely long service life. 3 pairs of groove rollers (pressure roller, counter-pressure roller) for the whole working range DN 25–300, 1–12", easy change. Grooving rollers Cu (pressure roller, counterpressure roller) for copper pipe 54–159 mm. Groove rollers INOX (pressure roller made of stainless steel, counter-pressure roller made of toughened, specially hardened steel, nickel-plated) for stainless steel pipes 1–1½", 2–6" and 8–12". Grooving rollers for aluminium, PVC pipes on request.

### Conversion kit for threading

Tool set 1/4"–2" complete with universal automatic die head, dies for pipe threads, tapered, ISO 7-1 (DIN 2999, BSPT) R 1/2"–3/4" and R 1–2" right-hand, pipe cutter, inner pipe deburrer, pressing lever, pump for automatic oiling, oil basin, chip tray.

### Material support

Extra sturdy REMS Herkules XL 12" material support for roll grooving of pipes up to 12" (page 107).



German Quality Product



Info



Stand  
(Accessory)



Wheel stand (Accessory)

Herkules 3B (Accessory)

### Supply format

**REMS Magnum RG.** Roll grooving machine for pipe grooving of pipe coupling systems DN 25–300, 1–12". With maintenance-free gear, safety foot switch with emergency-stop, self-tightening quick-action hammer chuck, rear centering device, automatic lubrication and cooling, tool support. Choice of 3 motors. Roll grooving attachment, hydraulic hand pump, built-in ring gauge with automatic groove-depth-stop, 1 set of grooving rollers (pressure roller, counterpressure roller) 2–6", hexagon key. For workbench, stand, collapsible wheel stand or wheel stand with material shelf. In a carton.

Description	Version	Art.-No.
<b>2000 RG-T</b>	Universal motor 230 V or 110 V, 50–60 Hz, 1700 W. 53 rpm.	340230
<b>2010 RG-T</b>	Pole-reversible capacitor motor 230 V, 50 Hz, 2100 W. 52/26 rpm, also under full load. Extremely quiet running.	340231
<b>2020 RG-T</b>	Pole-reversible 3~ induction motor 400 V, 50 Hz, 2000 W. 52/26 rpm, also under full load. Extremely quiet running.	340232

Other voltages on request.

### Accessories

Description	Art.-No.
<b>Stand</b>	344105
<b>Wheel stand with material support</b>	344100
<b>Collapsible wheel stand</b>	344150
<b>REMS Herkules material supports, see page 107.</b>	
<b>Grooving rollers and other accessories, see page 50.</b>	
<b>Conversion kit Magnum RG-T to L-T for threading.</b>	340110



Collapsible wheel stand (Accessory)

