

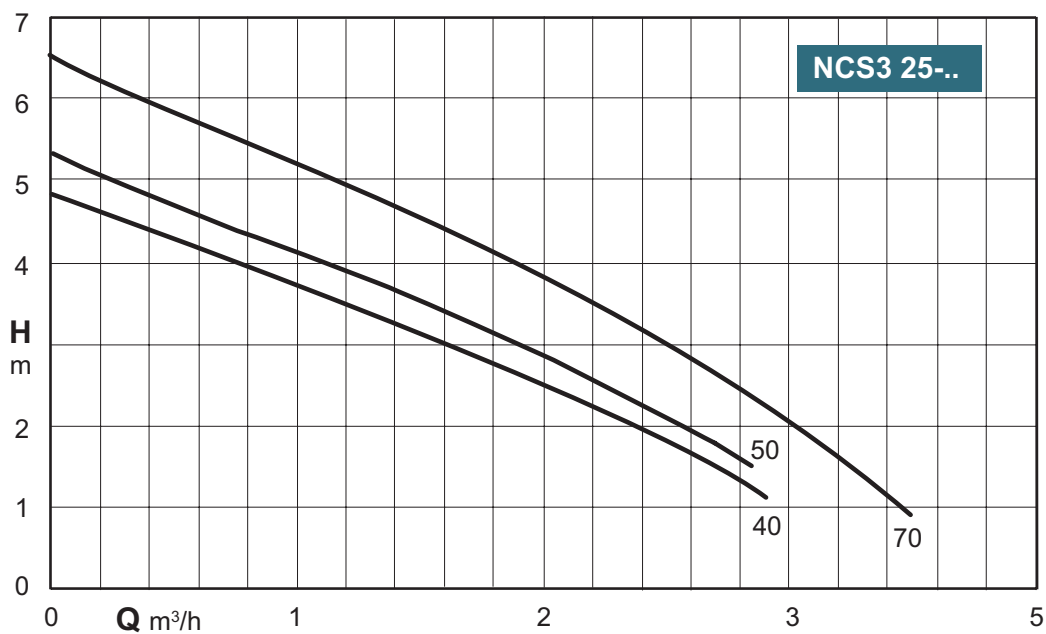

Coverage chart



Circulating pumps for sanitary hot water

Construction

3-speed circulator.
 Pump casing with suction and delivery connections with the same diameter and on the same axis (in-line).
 Bronze pump casing.
 Standard with brass unions.

Applications

Impianti di circolazione di acqua calda sanitaria.

Operating conditions

Liquid temperature from +5 °C to +65 °C.
 Ambient temperature up to 40 °C.
 Sound pressure ≤ 45 dB (A)
 Minimum suction pressure: 0,05 bar at 50 °C
 - Maximum permissible working pressure: 10 bar
 Storage: -10°C/+50°C max. relative humidity 95% at 40 °C
 Connections: threaded ports ISO 228: G 1 1/2.

Motor

2-pole induction motor, 50 Hz.
 Three adjustable speeds.
 NCS3: single-phase 230 V.
 Insulation class H.
 - Protection: IP 44
 Overload protection (integrated).
 - Cable: phases and neutral.
 Constructed in accordance with EN 60335-1, EN 60335-2-51.

Designation

NCS3 25 - 40 / 130
NCS3 = Series
25 = DN ports in mm
40 = Max. head in dm
130 = connection size mm

Materials

Component	Material
Pump casing	Bronze
Impeller	Composite PES
Shaft	Ceramic
Ball bearings	Ceramic
Thrust bearing	Ceramic
Rotor	jacket
Winding	Copper wire
Gasket	EPDM

Operating modes

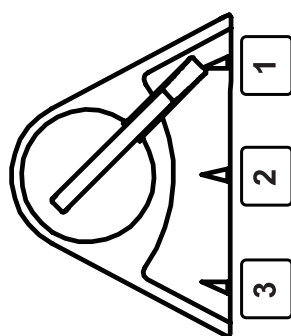

MANUAL PROGRAMMING

By positioning the selector at any point between 1,2 and 3, the most suitable operating curve for the system is manually chosen.

Characteristic curves $n \approx 2900$ rpm

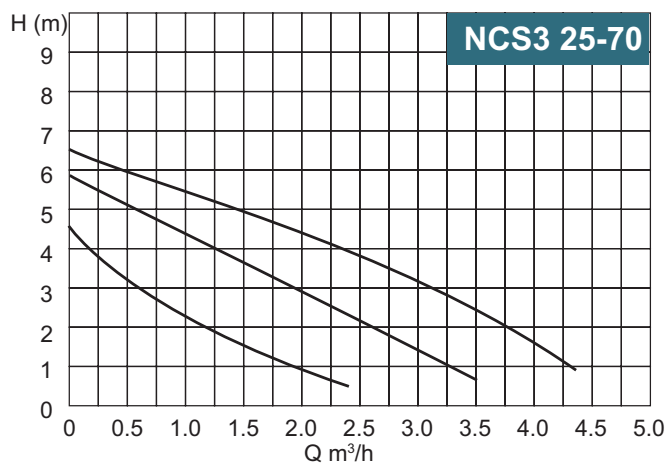
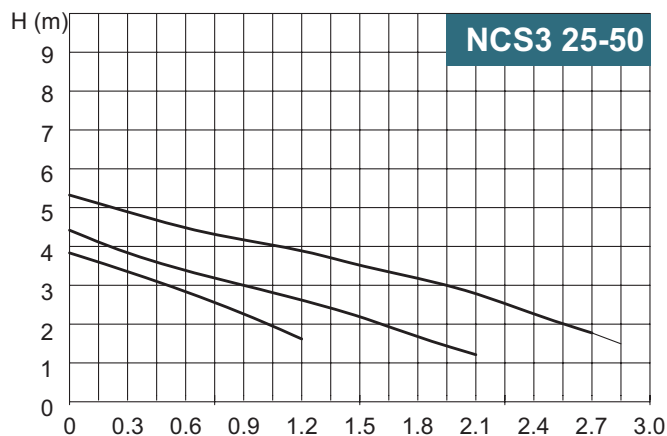
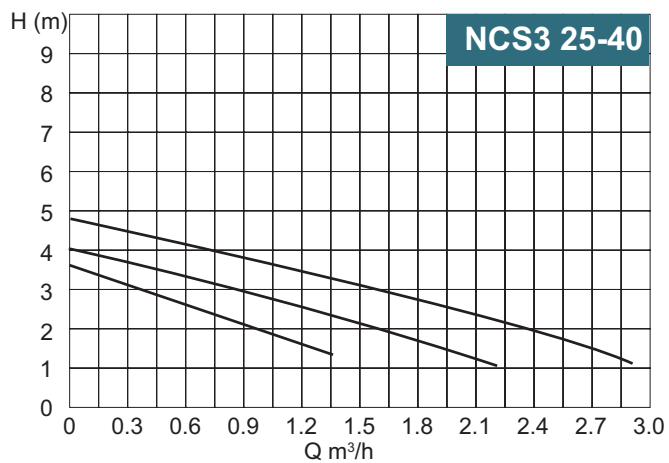

Dimensions and weights

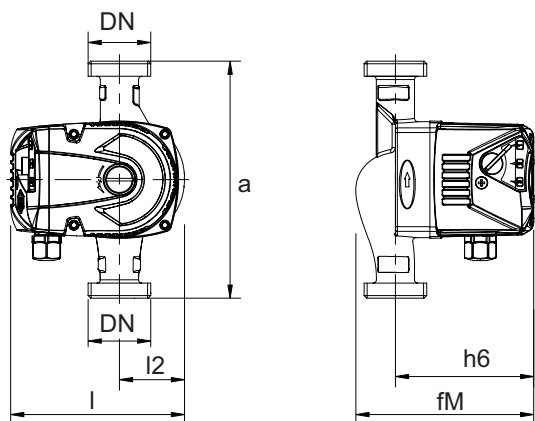

Unions

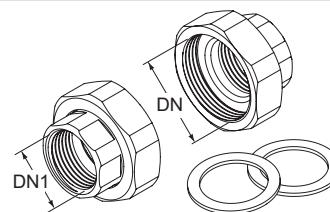

TYPE	DN	DN1
KIT G 1 1/4 - G 3/4 (NCS3 20..)	G 1 1/4	G 3/4
KIT G 1 1/2 - G 1 (NCS3 25..)	G 1 1/2	G 1

TYPE	DN	Pos.	P1 (W)	a	FM	l2	l	h6	kg
NCS3 25-40/130/A	G 1 1/2	3	72	130	135	49	132	105	2.5
		2	53						
		1	38						
NCS3 25-50/130/A	G 1 1/2	3	81	130	135	49	132	105	2.6
		2	67						
		1	46						
NCS3 25-70/130/A	G 1 1/2	3	122	130	135	49	132	105	2.7
		2	95						
		1	66						

Examples of installations

