

# 4 CONFIGURATION C<sub>93</sub>X - CONCENTRIC ALU/PPS PIPES (COMBUSTIVE AIR IN COUNTER-CURRENT)

MODULENS G®, TWINEO, ELIDENS DTG 130-45,  
INNOVENS PRO MCA 45, INNOVENS MCA, QUADRODENS, VIVADENS

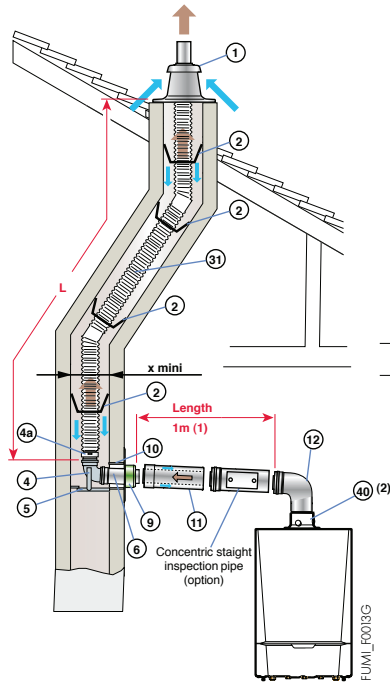

connect. Ø (mm)	Equivalent length (m)	
	80/125	80 flex
87° elbow	1,5	-
45° elbow	1,0	-
Staight inspection pipe	0,6	0,3
Inspection T	2,7	-
Inspection elbow	2,0	-
Condensates recup.	0,8	-

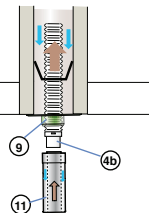

(1) For each additional metre of horizontal conduit, remove 1.2 m from the vertical length L<sub>max</sub> given in the table opposite.  
(2) Or location ③ or ④ where appropriate

Boiler shown: MCA connected with Ø 80/125 mm in boiler room and Ø 80 mm in chimney

Boiler type	connect. Ø (mm)		L <sub>max</sub> (m)
	- in boiler room	- to chimney	
QUADRODENS DUC 25-...	80/125	80	17
ELIDENS DTG 130-45 INNOVENS PRO MCA 45	80/125	80	12
MODULENS G® AGC 10 INNOVENS MCA 10	80/125	80	6,9
MODULENS G® AGC 15 INNOVENS MCA 15	80/125	80	11,1
MODULENS G® AGC 25 TWINEO EGC 25 INNOVENS MCA 25	80/125	80	20
MODULENS G® AGC 35 INNOVENS MCA 35	80/125	80	20
INNOVENS MCA 25/28 MI INNOVENS MCA 25/28 BIC	80/125	80	20
VIVADENS MCR 24	80/125	80	15,5
VIVADENS MCR 24/28 MI VIVADENS MCR 24/28 BIC	80/125	80	19
VIVADENS MCR 30/35 MI	80/125	80	18
VIVADENS MCR 34/39 MI	80/125	80	20
x min	□ (mm)	Ø (mm)	140
			160

⇒ Alu/PPS and PPS flue systems accessories needed at the very least for connection using flex pipes in an existing chimney flue:

Description	Diagrams with Dimensions/References	Boiler types	MODULENS G® AGC 10, 15, 25, 35, TWINEO, EGC 25, QUADRODENS		ELIDENS DTG 130-45, INNOVENS PRO MCA 45		INNOVENS MCA 10, 15, 25, 35, 25/28 MI 25/28 BIC, VIVADENS	
			connect. Ø - in boiler room (mm)		connect. Ø - in boiler room (mm)		connect. Ø - in boiler room (mm)	
			80/125		80/125		80/125	
			perpendicular to the conduit	in conduit	perpendicular to the conduit	in conduit	perpendicular to the conduit	in conduit
Boiler connection kit Ø 80/125 mm perpendicular to the conduit	DY 849 	DY 850 	X		X		X	
Boiler connection kit Ø 80/125 mm in conduit				X		X		X
Adapter flex pipe				X		X		X
Chimney connection kit Ø 80 mm			X		X		X	
Air/flue gas vent with flashing for flex pipe				X		X		X
Adapter Ø 80/125 to 60/100 mm	DY 708 	HR 38 	X					
Adapter Ø 80/125 mm							X	
Condensates recuperator Ø 80/125 mm					X			
Flex pipe Ø 80 mm L 12.5 m (1)			X		X		X	

(1) other flex pipe lengths available - see next page

# 4 CONFIGURATION C<sub>93</sub>X - CONCENTRIC ALU/PPS PIPES (COMBUSTIVE AIR IN COUNTER-CURRENT)

ELIDENS DTG 130-65 TO 115, INNOVENS PRO MCA 65 TO 115

Boiler type	connect. Ø (mm)		Lmax (m)
	- in boiler room	- to chimney	
ELIDENS DTG 130-65 INNOVENS PRO MCA 65	110/150	110	16,5
ELIDENS DTG 130-90 INNOVENS PRO MCA 90	110/150	110	13,5
ELIDENS DTG 130-115 INNOVENS PRO MCA 115	110/150	110	9,4
x min	□ (mm)	Ø (mm)	170
			190

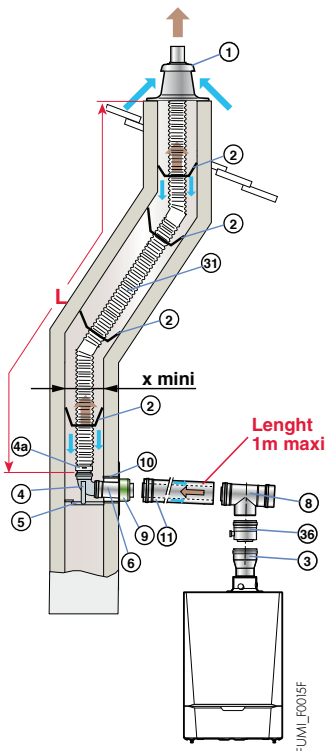

connect. Ø (mm)	Equivalent length (m)	
	110/150	110 flex
87° elbow	3,7	-
45° elbow	1,0	-
Straight inspection pipe	1,0	0,5
Inspection T	2,5	-
Condensates recup.	0,6	-

(I) For each additional metre of horizontal conduit, remove 1.2 m from the vertical length Lmax given in the table opposite.



Boiler shown:  
MCA 65 to 115 mm

⇒ Alu/PPS or PPS flue systems accessories needed at the very least for air/flue gas connection using flex pipes in an existing chimney flue:

Description	Diagrams with Dimensions/References	Boiler types	ELIDENS DTG 130-65 to 115, INNOVENS PRO MCA 65 to 115
		connect. Ø (mm) - in boiler room - in chimney	110/150 110
		Package/ Ref.	
Boiler connection kit Ø 110/150 mm		DY 818 100002360	X
Chimney connection kit Ø 110 mm		DY 888 100015287	X
Adapter Ø 100/150 mm to Ø 110/150 mm		DY 817 100002357	X
Condensates recuperator Ø 110/150 mm		DY 918 100018984	X
Flex pipe Ø 110 mm L 15 m (1)		DY 889 100015288	X



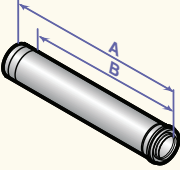
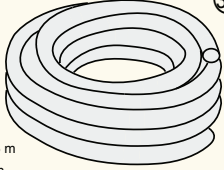
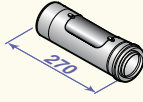
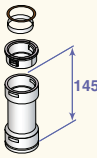
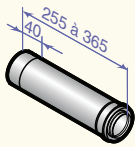
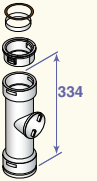
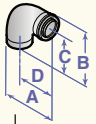
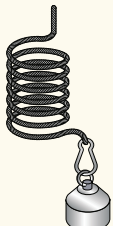
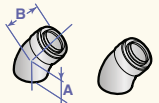
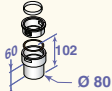
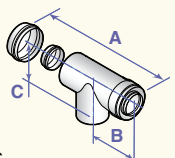
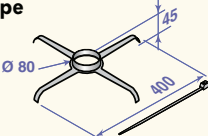

# IN BOILER ROOM, SINGLE “FLEX” PPS PIPES IN CHIMNEY

⇒ Other concentric Alu/PPS or single PPS (flex) flue systems accessories available:

<p><b>Concentric extension</b></p>  <table border="1" data-bbox="159 515 399 616"> <thead> <tr> <th></th> <th>A</th> <th>B</th> </tr> </thead> <tbody> <tr> <td>DY 126</td> <td>250</td> <td>200</td> </tr> <tr> <td>DY 127</td> <td>500</td> <td>450</td> </tr> <tr> <td>DY 128</td> <td>1000</td> <td>950</td> </tr> <tr> <td>DY 129</td> <td>1950</td> <td>1900</td> </tr> </tbody> </table>		A	B	DY 126	250	200	DY 127	500	450	DY 128	1000	950	DY 129	1950	1900	<p>⑪</p> <table border="1"> <thead> <tr> <th>Ø 80/125 mm</th> <th>L (mm)</th> <th>Ref.</th> </tr> </thead> <tbody> <tr> <td>DY 126</td> <td>250</td> <td>84887526</td> </tr> <tr> <td>DY 127</td> <td>500</td> <td>84887527</td> </tr> <tr> <td>DY 128</td> <td>1000</td> <td>84887528</td> </tr> <tr> <td>DY 129</td> <td>1950</td> <td>84887529</td> </tr> </tbody> </table>	Ø 80/125 mm	L (mm)	Ref.	DY 126	250	84887526	DY 127	500	84887527	DY 128	1000	84887528	DY 129	1950	84887529	<p><b>Flex pipe</b></p>  <table border="1" data-bbox="837 414 965 459"> <tbody> <tr> <td>DY 897</td> <td>12,5 m</td> </tr> <tr> <td>DY 896</td> <td>50 m</td> </tr> </tbody> </table>	DY 897	12,5 m	DY 896	50 m	<table border="1"> <thead> <tr> <th>Ø 80 mm</th> <th>L (m)</th> <th>Ref.</th> </tr> </thead> <tbody> <tr> <td>DY 897</td> <td>12,5</td> <td>100015327</td> </tr> <tr> <td>DY 896</td> <td>50</td> <td>100015326</td> </tr> </tbody> </table>	Ø 80 mm	L (m)	Ref.	DY 897	12,5	100015327	DY 896	50	100015326
	A	B																																												
DY 126	250	200																																												
DY 127	500	450																																												
DY 128	1000	950																																												
DY 129	1950	1900																																												
Ø 80/125 mm	L (mm)	Ref.																																												
DY 126	250	84887526																																												
DY 127	500	84887527																																												
DY 128	1000	84887528																																												
DY 129	1950	84887529																																												
DY 897	12,5 m																																													
DY 896	50 m																																													
Ø 80 mm	L (m)	Ref.																																												
DY 897	12,5	100015327																																												
DY 896	50	100015326																																												
<p><b>Concentric staight inspection pipe</b></p> 	<p>⑦</p> <table border="1"> <thead> <tr> <th>Ø 80/125 mm</th> <th>Ref.</th> </tr> </thead> <tbody> <tr> <td>DY 124</td> <td>84887524</td> </tr> </tbody> </table>	Ø 80/125 mm	Ref.	DY 124	84887524	<p><b>Coupling component for flex pipe</b></p> 	<table border="1"> <thead> <tr> <th>Ø 80 mm</th> <th>Ref.</th> </tr> </thead> <tbody> <tr> <td>DY 898</td> <td>100015328</td> </tr> </tbody> </table>	Ø 80 mm	Ref.	DY 898	100015328																																			
Ø 80/125 mm	Ref.																																													
DY 124	84887524																																													
Ø 80 mm	Ref.																																													
DY 898	100015328																																													
<p><b>Concentric compensation sleeve</b></p> 	<p>⑰</p> <table border="1"> <thead> <tr> <th>Ø 80/125 mm</th> <th>Ref.</th> </tr> </thead> <tbody> <tr> <td>DY 130</td> <td>84887530</td> </tr> </tbody> </table>	Ø 80/125 mm	Ref.	DY 130	84887530	<p><b>Inspection pipe for flex pipe</b></p> 	<table border="1"> <thead> <tr> <th>Ø 80 mm</th> <th>Ref.</th> </tr> </thead> <tbody> <tr> <td>DY 900</td> <td>100015330</td> </tr> </tbody> </table>	Ø 80 mm	Ref.	DY 900	100015330																																			
Ø 80/125 mm	Ref.																																													
DY 130	84887530																																													
Ø 80 mm	Ref.																																													
DY 900	100015330																																													
<p><b>Concentric elbow at 87°</b></p>  <table border="1" data-bbox="159 1198 391 1243"> <thead> <tr> <th></th> <th>A</th> <th>B</th> <th>C</th> <th>D</th> </tr> </thead> <tbody> <tr> <td>DY 131</td> <td>183</td> <td>185</td> <td>120</td> <td>130</td> </tr> </tbody> </table>		A	B	C	D	DY 131	183	185	120	130	<p>⑫</p> <table border="1"> <thead> <tr> <th>Ø 80/125 mm</th> <th>Angle</th> <th>Ref.</th> </tr> </thead> <tbody> <tr> <td>DY 131</td> <td>87°</td> <td>84887531</td> </tr> <tr> <td>DY 132</td> <td>45° (2-pieces)</td> <td>84887532</td> </tr> </tbody> </table>	Ø 80/125 mm	Angle	Ref.	DY 131	87°	84887531	DY 132	45° (2-pieces)	84887532	<p><b>Insertion tool for flex pipe</b></p> 	<table border="1"> <thead> <tr> <th>Ø 80 mm</th> <th>Ref.</th> </tr> </thead> <tbody> <tr> <td>DY 901</td> <td>100015331</td> </tr> </tbody> </table>	Ø 80 mm	Ref.	DY 901	100015331																				
	A	B	C	D																																										
DY 131	183	185	120	130																																										
Ø 80/125 mm	Angle	Ref.																																												
DY 131	87°	84887531																																												
DY 132	45° (2-pieces)	84887532																																												
Ø 80 mm	Ref.																																													
DY 901	100015331																																													
<p><b>at 45°</b></p>  <table border="1" data-bbox="159 1377 311 1422"> <thead> <tr> <th></th> <th>A</th> <th>B</th> </tr> </thead> <tbody> <tr> <td>DY 132</td> <td>90</td> <td>90</td> </tr> </tbody> </table>		A	B	DY 132	90	90		<p><b>Adapters for flex pipe</b></p> 	<table border="1"> <thead> <tr> <th>Ø 80 mm</th> <th>Ref.</th> </tr> </thead> <tbody> <tr> <td>DY 904</td> <td>100015880</td> </tr> </tbody> </table>	Ø 80 mm	Ref.	DY 904	100015880																																	
	A	B																																												
DY 132	90	90																																												
Ø 80 mm	Ref.																																													
DY 904	100015880																																													
<p><b>Inspection T concentric</b></p>  <table border="1" data-bbox="159 1635 343 1680"> <thead> <tr> <th></th> <th>A</th> <th>B</th> <th>C</th> </tr> </thead> <tbody> <tr> <td>DY 125</td> <td>270</td> <td>140</td> <td>120</td> </tr> </tbody> </table>		A	B	C	DY 125	270	140	120	<p>⑧</p> <table border="1"> <thead> <tr> <th>Ø 80/125 mm</th> <th>Ref.</th> </tr> </thead> <tbody> <tr> <td>DY 125</td> <td>84887525</td> </tr> </tbody> </table>	Ø 80/125 mm	Ref.	DY 125	84887525	<p><b>Centering star for flex pipe</b></p> 	<table border="1"> <thead> <tr> <th>Ø 80 mm</th> <th>Ref.</th> </tr> </thead> <tbody> <tr> <td>DY 618 (2 pieces)</td> <td>84887618</td> </tr> </tbody> </table>	Ø 80 mm	Ref.	DY 618 (2 pieces)	84887618																											
	A	B	C																																											
DY 125	270	140	120																																											
Ø 80/125 mm	Ref.																																													
DY 125	84887525																																													
Ø 80 mm	Ref.																																													
DY 618 (2 pieces)	84887618																																													
<p><b>Inspection elbow concentric</b></p> 	<p>⑳</p> <table border="1"> <thead> <tr> <th>Ø 80/125 mm</th> <th>Ref.</th> </tr> </thead> <tbody> <tr> <td>DY 875</td> <td>100008311</td> </tr> </tbody> </table>	Ø 80/125 mm	Ref.	DY 875	100008311	<p><b>Stainless steel protection screen for roof outlet</b></p> 	<table border="1"> <thead> <tr> <th>Ø 90 mm</th> <th>Ref.</th> </tr> </thead> <tbody> <tr> <td>-</td> <td>300007172</td> </tr> </tbody> </table>	Ø 90 mm	Ref.	-	300007172																																			
Ø 80/125 mm	Ref.																																													
DY 875	100008311																																													
Ø 90 mm	Ref.																																													
-	300007172																																													

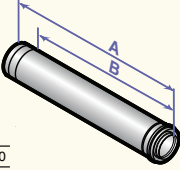
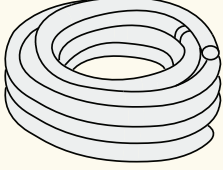
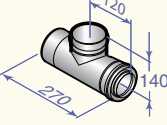
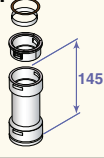
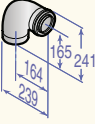
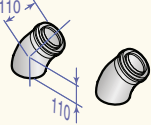
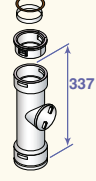
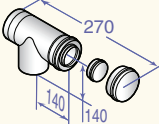
# IN BOILER ROOM, SINGLE "FLEX" PPS PIPES IN CHIMNEY

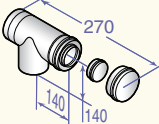
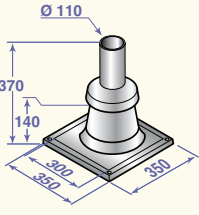
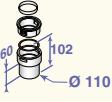
⇨ Other concentric Alu/PPS or single PPS (flex) flue systems accessories available:

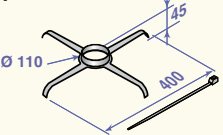
<p><b>Concentric extension</b></p>  <table border="1" data-bbox="156 443 300 499"> <thead> <tr> <th></th> <th>A</th> <th>B</th> </tr> </thead> <tbody> <tr> <td>DY 811</td> <td>500</td> <td>450</td> </tr> <tr> <td>DY 812</td> <td>1000</td> <td>950</td> </tr> </tbody> </table>		A	B	DY 811	500	450	DY 812	1000	950	<p>⑪</p> <table border="1"> <thead> <tr> <th>Ø 110/150 mm</th> <th>L (mm)</th> <th>Ref.</th> </tr> </thead> <tbody> <tr> <td>DY 811</td> <td>500</td> <td>100002351</td> </tr> <tr> <td>DY 812</td> <td>1000</td> <td>100002352</td> </tr> </tbody> </table>	Ø 110/150 mm	L (mm)	Ref.	DY 811	500	100002351	DY 812	1000	100002352	<p><b>Flex pipe</b></p>  <p>③①</p> <table border="1"> <thead> <tr> <th>Ø 110 mm</th> <th>L (m)</th> <th>Ref.</th> </tr> </thead> <tbody> <tr> <td>DY 889</td> <td>15</td> <td>100015288</td> </tr> <tr> <td>DY 890</td> <td>25</td> <td>100015289</td> </tr> </tbody> </table>	Ø 110 mm	L (m)	Ref.	DY 889	15	100015288	DY 890	25	100015289
	A	B																											
DY 811	500	450																											
DY 812	1000	950																											
Ø 110/150 mm	L (mm)	Ref.																											
DY 811	500	100002351																											
DY 812	1000	100002352																											
Ø 110 mm	L (m)	Ref.																											
DY 889	15	100015288																											
DY 890	25	100015289																											
<p><b>Concentric inspection sleeve</b></p> 	<p>⑦</p> <table border="1"> <thead> <tr> <th>Ø 110/150 mm</th> <th>Ref.</th> </tr> </thead> <tbody> <tr> <td>DY 815</td> <td>100002355</td> </tr> </tbody> </table>	Ø 110/150 mm	Ref.	DY 815	100002355	<p><b>Coupling component for flex pipe</b></p>  <p>③②</p> <table border="1"> <thead> <tr> <th>Ø 110 mm</th> <th>Ref.</th> </tr> </thead> <tbody> <tr> <td>DY 891</td> <td>100015321</td> </tr> </tbody> </table>	Ø 110 mm	Ref.	DY 891	100015321																			
Ø 110/150 mm	Ref.																												
DY 815	100002355																												
Ø 110 mm	Ref.																												
DY 891	100015321																												
<p><b>Concentric elbow at 87°</b></p>  <p><b>at 45°</b></p> 	<p>⑫</p> <table border="1"> <thead> <tr> <th>Ø 110/150 mm</th> <th>Angle</th> <th>Ref.</th> </tr> </thead> <tbody> <tr> <td>DY 813</td> <td>87°</td> <td>100002353</td> </tr> <tr> <td>DY 814</td> <td>45° (2-pieces)</td> <td>100002354</td> </tr> </tbody> </table>	Ø 110/150 mm	Angle	Ref.	DY 813	87°	100002353	DY 814	45° (2-pieces)	100002354	<p><b>Inspection pipe for flex pipe</b></p>  <p>③⑧</p> <table border="1"> <thead> <tr> <th>Ø 110 mm</th> <th>Ref.</th> </tr> </thead> <tbody> <tr> <td>DY 893</td> <td>100015323</td> </tr> </tbody> </table>	Ø 110 mm	Ref.	DY 893	100015323														
Ø 110/150 mm	Angle	Ref.																											
DY 813	87°	100002353																											
DY 814	45° (2-pieces)	100002354																											
Ø 110 mm	Ref.																												
DY 893	100015323																												
<p><b>Concentric inspection T</b></p> 	<p>⑧</p> <table border="1"> <thead> <tr> <th>Ø 110/150 mm</th> <th>Ref.</th> </tr> </thead> <tbody> <tr> <td>DY 816</td> <td>100002356</td> </tr> </tbody> </table>	Ø 110/150 mm	Ref.	DY 816	100002356	<p><b>Insertion tool for flex pipe</b></p>  <p>③③</p> <table border="1"> <thead> <tr> <th>Ø 110 mm</th> <th>Ref.</th> </tr> </thead> <tbody> <tr> <td>DY 894</td> <td>100015324</td> </tr> </tbody> </table>	Ø 110 mm	Ref.	DY 894	100015324																			
Ø 110/150 mm	Ref.																												
DY 816	100002356																												
Ø 110 mm	Ref.																												
DY 894	100015324																												
<p><b>Concentric inspection T</b></p> 	<p>⑧</p> <table border="1"> <thead> <tr> <th>Ø 110/150 mm</th> <th>Ref.</th> </tr> </thead> <tbody> <tr> <td>DY 816</td> <td>100002356</td> </tr> </tbody> </table>	Ø 110/150 mm	Ref.	DY 816	100002356	<p><b>Air/flue gas vent with flashing for flex pipe</b></p>  <p>①</p> <table border="1"> <thead> <tr> <th>Ø 110 mm</th> <th>Ref.</th> </tr> </thead> <tbody> <tr> <td>DY 892</td> <td>100015322</td> </tr> </tbody> </table>	Ø 110 mm	Ref.	DY 892	100015322																			
Ø 110/150 mm	Ref.																												
DY 816	100002356																												
Ø 110 mm	Ref.																												
DY 892	100015322																												
<p><b>Adapters for flex pipe</b></p> 	<p>⑧</p> <table border="1"> <thead> <tr> <th>Ø 110 mm</th> <th>Ref.</th> </tr> </thead> <tbody> <tr> <td>DY 905</td> <td>100015881</td> </tr> </tbody> </table>	Ø 110 mm	Ref.	DY 905	100015881	<p><b>Adapters for flex pipe</b></p> <table border="1"> <thead> <tr> <th>Ø 110 mm</th> <th>Ref.</th> </tr> </thead> <tbody> <tr> <td>DY 905</td> <td>100015881</td> </tr> </tbody> </table>	Ø 110 mm	Ref.	DY 905	100015881																			
Ø 110 mm	Ref.																												
DY 905	100015881																												
Ø 110 mm	Ref.																												
DY 905	100015881																												
<p><b>Stainless steel protection screen for roof outlet</b></p> 	<p>③④</p> <table border="1"> <thead> <tr> <th>Ø 120 mm</th> <th>Ref.</th> </tr> </thead> <tbody> <tr> <td>-</td> <td>300007173</td> </tr> </tbody> </table>	Ø 120 mm	Ref.	-	300007173	<p><b>Stainless steel protection screen for roof outlet</b></p> <table border="1"> <thead> <tr> <th>Ø 120 mm</th> <th>Ref.</th> </tr> </thead> <tbody> <tr> <td>-</td> <td>300007173</td> </tr> </tbody> </table>	Ø 120 mm	Ref.	-	300007173																			
Ø 120 mm	Ref.																												
-	300007173																												
Ø 120 mm	Ref.																												
-	300007173																												
<p><b>Centering star for flex pipe</b></p> 	<p>③⑨</p> <table border="1"> <thead> <tr> <th>Ø 110 mm</th> <th>Ref.</th> </tr> </thead> <tbody> <tr> <td>DY 805 (4 pieces)</td> <td>100002282</td> </tr> </tbody> </table>	Ø 110 mm	Ref.	DY 805 (4 pieces)	100002282	<p><b>Centering star for flex pipe</b></p> <table border="1"> <thead> <tr> <th>Ø 110 mm</th> <th>Ref.</th> </tr> </thead> <tbody> <tr> <td>DY 805 (4 pieces)</td> <td>100002282</td> </tr> </tbody> </table>	Ø 110 mm	Ref.	DY 805 (4 pieces)	100002282																			
Ø 110 mm	Ref.																												
DY 805 (4 pieces)	100002282																												
Ø 110 mm	Ref.																												
DY 805 (4 pieces)	100002282																												