

CONFIGURATION C_{93x} - CONCENTRIC ALU/PPS PIPES (COMBUSTIVE AIR IN COUNTER-CURRENT)

VIVADENS, QUADRODENS, MODULENS G®, TWINEO, INNOVENS MCA

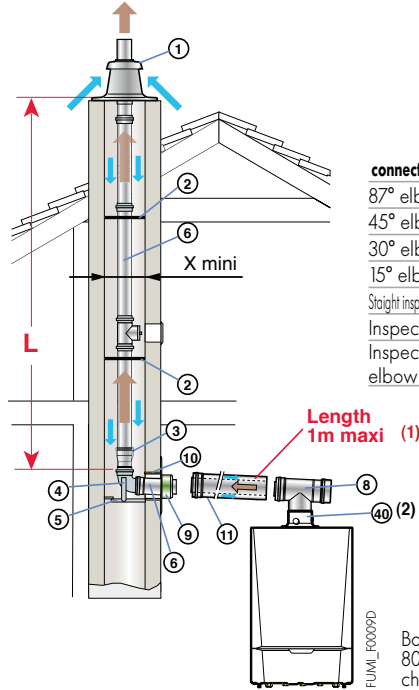

connect. Ø (mm)	Equivalent length (m)			
	60/100	80/125	60	80
87° elbow	1,1	1,5	1,1	1,9
45° elbow	0,8	1,0	0,6	1,2
30° elbow	0,7	-	0,9	0,4
15° elbow	0,5	-	0,6	0,2
Straight inspection pipe	0,5	0,6	0,3	0,3
Inspection T	2,2	2,7	2,9	4,2
Inspection elbow	-	2,0	-	0,7

(1) For each additional metre of horizontal conduit, remove 1.2 m from the vertical length L_{max} given in the table opposite.
(2) Or location (3) where appropriate

Boiler shown: MCA 35 connected with Ø 80/125 mm in boiler room and Ø 80 mm to chimney

Boiler type	connect. Ø (mm) - in boiler room - to chimney	L _{max} (m)		
		60/100	80	80/125
QUADRODENS DUC 25-...		13	20	-
MODULENS G® AGC 10 INNOVENS MCA 10		8,5	5,8	-
MODULENS G® AGC 15 INNOVENS MCA 15		15	9,9	-
MODULENS G® AGC 25 TWINEO EGC 25 INNOVENS MCA 25		8,1	20	-
MODULENS G® AGC 35 INNOVENS MCA 35		2,8	18	20
INNOVENS MCA 25/28 MI		9	20	-
INNOVENS MCA 25/28 BIC		9	20	-
VIVADENS MCR 24		-	18	-
VIVADENS MCR 24/28 MI VIVADENS MCR 24/28 BIC		-	20	-
VIVADENS MCR 30/35 MI		-	10	20
VIVADENS MCR 34/39 MI		-	12	20
	x min	120	140	140
	Ø (mm)	140	160	160

⇒ Alu/PPS or PPS flue systems accessories needed at the very least for air/flue gas connections using rigid pipes in an existing chimney flue:

Description	Diagrams with Dimensions/References	Boil. type/ connect. (mm) - in boiler room Package/Ref.	MODULENS G® AGC 10, 15, 25, 35, TWINEO EGC 25, QUADRODENS DUC 25, INNOVENS MCA 10, 15, 25, 25/28 MI, 25/28 BIC		INNOVENS MCA 35		VIVADENS MCR 24, 24/28 MI 24/28 BIC	VIVADENS MCR 30/35 MI, MCR 34/39 MI																								
			60/100	60/100	60/100	60/100	80/125	60/100	60/100	80/125																						
Boiler connection kit Ø 60/100 mm	<table border="1"> <tr> <td></td> <td>A</td> <td>B</td> <td>C</td> <td>D</td> <td>E</td> </tr> <tr> <td>DY 702</td> <td>250</td> <td>120</td> <td>100</td> <td>115</td> <td>100</td> </tr> <tr> <td>DY 716</td> <td>270</td> <td>130</td> <td>120</td> <td>140</td> <td>125</td> </tr> </table>		A	B	C	D	E	DY 702	250	120	100	115	100	DY 716	270	130	120	140	125	X	X	X	X		X	X						
		A	B	C	D	E																										
DY 702	250	120	100	115	100																											
DY 716	270	130	120	140	125																											
Boiler connection kit Ø 80/125 mm							X		X																							
Chimney connection kit Ø 60 mm	<table border="1"> <tr> <td></td> <td>A</td> <td>B</td> <td>C</td> <td>D</td> <td>E</td> </tr> <tr> <td>DY 700</td> <td>60</td> <td>60</td> <td>110</td> <td>120</td> <td>180</td> </tr> <tr> <td>DY 701</td> <td>60</td> <td>80</td> <td>110</td> <td>120</td> <td>180</td> </tr> <tr> <td>DY 717</td> <td>80</td> <td>125</td> <td>120</td> <td>130</td> <td>210</td> </tr> </table> <p>* Only for DY 701</p>		A	B	C	D	E	DY 700	60	60	110	120	180	DY 701	60	80	110	120	180	DY 717	80	125	120	130	210	X		X				
		A	B	C	D	E																										
DY 700		60	60	110	120	180																										
DY 701	60	80	110	120	180																											
DY 717	80	125	120	130	210																											
Chimney connection kit Ø 80 mm with adapter Ø 60 to 80 mm			X		X		X	X																								
Chimney connection kit Ø 80 mm							X		X																							
Adapter Ø 80/125 mm		HR 38 S100465					X		X																							

3 CONFIGURATION C_{93x} - CONCENTRIC ALU/PPS PIPES (COMBUSTIVE AIR IN COUNTER-CURRENT)

ELIDENS DTG 130-45 TO 115, INNOVENS PRO MCA 45 TO 115

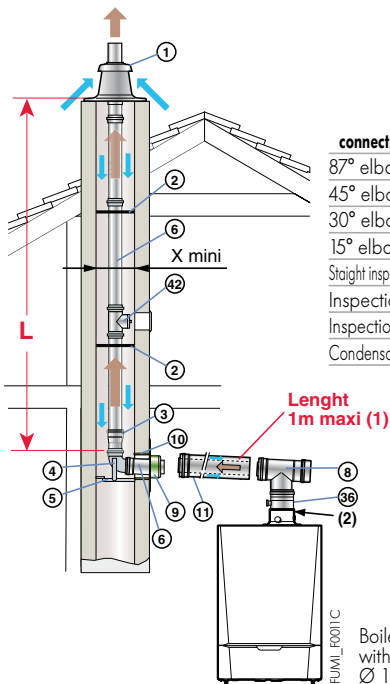

connect. Ø (mm)	Equivalent length (m)			
	80/125	110/150	80	110
87° elbow	1,5	3,7	1,9	4,9
45° elbow	1,0	1,0	1,2	1,1
30° elbow	-	-	0,4	-
15° elbow	-	-	0,2	-
Straight inspection pipe	0,6	1,0	0,3	-
Inspection T	2,7	2,5	4,2	5,6
Inspection elbow	2,0	-	0,7	4,8
Condensates recup.	0,8	0,6	1,3	0,1

Boiler type	connect. Ø (mm)		Lmax (m)	
	- in boiler room	- to chimney	80/125	110/150
ELIDENS DTG 130-45 INNOVENS PRO MCA 45	15	20	-	-
ELIDENS DTG 130-65 INNOVENS PRO MCA 65	-	-	-	16
ELIDENS DTG 130-90 INNOVENS PRO MCA 90	-	-	-	13,2
ELIDENS DTG 130-115 INNOVENS PRO MCA 115	-	-	-	10
x min	⊠ (mm)	⊘ (mm)	140	160
			160	180

(1) For each additional metre of horizontal conduit, remove 1.2 m from the vertical length Lmax given in the table opposite.
(2) Or location ③ where appropriate

Boiler shown: MCA 45 connected with Ø 80/125 mm in boiler room and Ø 110 mm to chimney







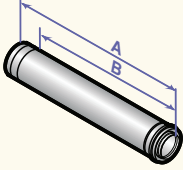
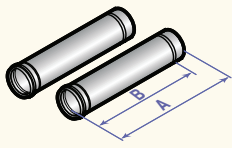
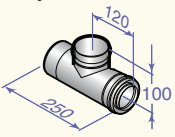
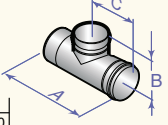
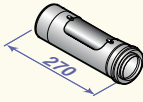
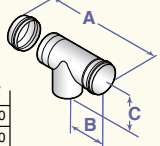
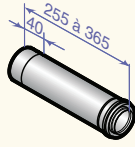

⇒ Alu/PPS or PPS flue systems accessories needed at the very least for air/flue gas connections using rigid pipes in an existing chimney flue:

Description	Diagrams with Dimensions/References	Boil. type	ELIDENS DTG 130-45, INNOVENS PRO MCA 45		ELIDENS DTG 130-65 to 115, INNOVENS PRO MCA 65 to 115	
			connect. Ø (mm)	- in boiler room	80/125	80/125
			- in chimney	80	110	110
Boiler connection kit Ø 80/125 mm		DY 716 84887716		X	X	
Boiler connection kit Ø 110/150 mm		DY 818 100002360				X
Chimney connection kit Ø 80 mm		DY 717 84887717		X		
Chimney connection kit Ø 110 mm with adapter Ø 80 to 110 mm		DY 876 100008312			X	
Chimney connection kit Ø 110 mm		DY 177 84887577				X
Condensates recuperator Ø 80/125 mm		DY 916 100018981		X	X	
Condensates recuperator Ø 110/150 mm		DY 918 100018984				X
Adapter Ø 110/150 to 100/150 mm		DY 817 100002357				X

* Only for DY 876

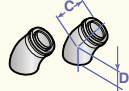
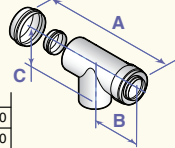
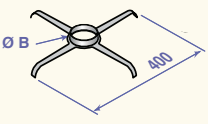

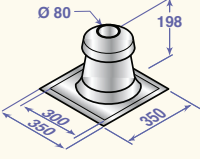



IN BOILER ROOM, SINGLE "RIGID" PPS PIPES IN CHIMNEY

⇒ Other Alu/PPS and single PPS flue systems accessories available:

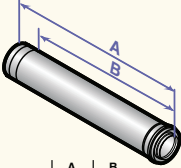
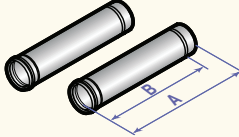
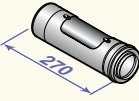
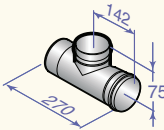
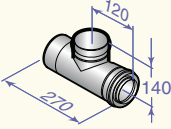
<p>Concentric extension ⑪</p>  <table border="1" data-bbox="159 548 399 649"> <thead> <tr> <th></th> <th>A</th> <th>B</th> </tr> </thead> <tbody> <tr> <td>DY 126</td> <td>250</td> <td>200</td> </tr> <tr> <td>DY 681, DY 127</td> <td>500</td> <td>450</td> </tr> <tr> <td>DY 682, DY 128</td> <td>1000</td> <td>950</td> </tr> <tr> <td>DY 683, DY 129</td> <td>1950</td> <td>1900</td> </tr> </tbody> </table>		A	B	DY 126	250	200	DY 681, DY 127	500	450	DY 682, DY 128	1000	950	DY 683, DY 129	1950	1900	<table border="1"> <thead> <tr> <th>Ø 60/100 mm</th> <th>L (mm)</th> <th>Ref.</th> </tr> </thead> <tbody> <tr> <td>DY 681</td> <td>500</td> <td>84887681</td> </tr> <tr> <td>DY 682</td> <td>1000</td> <td>84887682</td> </tr> <tr> <td>DY 683</td> <td>1950</td> <td>84887683</td> </tr> </tbody> </table> <table border="1"> <thead> <tr> <th>Ø 80/125 mm</th> <th>L (mm)</th> <th>Ref.</th> </tr> </thead> <tbody> <tr> <td>DY 126</td> <td>250</td> <td>84887526</td> </tr> <tr> <td>DY 127</td> <td>500</td> <td>84887527</td> </tr> <tr> <td>DY 128</td> <td>1000</td> <td>84887528</td> </tr> <tr> <td>DY 129</td> <td>1950</td> <td>84887529</td> </tr> </tbody> </table>	Ø 60/100 mm	L (mm)	Ref.	DY 681	500	84887681	DY 682	1000	84887682	DY 683	1950	84887683	Ø 80/125 mm	L (mm)	Ref.	DY 126	250	84887526	DY 127	500	84887527	DY 128	1000	84887528	DY 129	1950	84887529	<p>Single extension ⑥</p>  <table border="1" data-bbox="837 526 1077 638"> <thead> <tr> <th></th> <th>A</th> <th>B</th> </tr> </thead> <tbody> <tr> <td>DY 613</td> <td>250</td> <td>200</td> </tr> <tr> <td>DY 614, DY 690</td> <td>500</td> <td>450</td> </tr> <tr> <td>DY 615, DY 691</td> <td>1000</td> <td>950</td> </tr> <tr> <td>DY 150, DY 692</td> <td>1950</td> <td>1900</td> </tr> </tbody> </table> <table border="1"> <thead> <tr> <th>Ø 60 mm</th> <th>L (mm)</th> <th>Ref.</th> </tr> </thead> <tbody> <tr> <td>DY 690</td> <td>500 (2 pieces)</td> <td>84887690</td> </tr> <tr> <td>DY 691</td> <td>1000 (2 pieces)</td> <td>84887691</td> </tr> <tr> <td>DY 692</td> <td>1950 (2 pieces)</td> <td>84887692</td> </tr> </tbody> </table> <table border="1"> <thead> <tr> <th>Ø 80 mm</th> <th>L (mm)</th> <th>Ref.</th> </tr> </thead> <tbody> <tr> <td>DY 613</td> <td>250 (2 pieces)</td> <td>84887613</td> </tr> <tr> <td>DY 614</td> <td>500 (2 pieces)</td> <td>84887614</td> </tr> <tr> <td>DY 615</td> <td>1000 (2 pieces)</td> <td>84887615</td> </tr> <tr> <td>DY 150</td> <td>1950 (2 pieces)</td> <td>84887550</td> </tr> </tbody> </table>		A	B	DY 613	250	200	DY 614, DY 690	500	450	DY 615, DY 691	1000	950	DY 150, DY 692	1950	1900	Ø 60 mm	L (mm)	Ref.	DY 690	500 (2 pieces)	84887690	DY 691	1000 (2 pieces)	84887691	DY 692	1950 (2 pieces)	84887692	Ø 80 mm	L (mm)	Ref.	DY 613	250 (2 pieces)	84887613	DY 614	500 (2 pieces)	84887614	DY 615	1000 (2 pieces)	84887615	DY 150	1950 (2 pieces)	84887550	
	A	B																																																																																					
DY 126	250	200																																																																																					
DY 681, DY 127	500	450																																																																																					
DY 682, DY 128	1000	950																																																																																					
DY 683, DY 129	1950	1900																																																																																					
Ø 60/100 mm	L (mm)	Ref.																																																																																					
DY 681	500	84887681																																																																																					
DY 682	1000	84887682																																																																																					
DY 683	1950	84887683																																																																																					
Ø 80/125 mm	L (mm)	Ref.																																																																																					
DY 126	250	84887526																																																																																					
DY 127	500	84887527																																																																																					
DY 128	1000	84887528																																																																																					
DY 129	1950	84887529																																																																																					
	A	B																																																																																					
DY 613	250	200																																																																																					
DY 614, DY 690	500	450																																																																																					
DY 615, DY 691	1000	950																																																																																					
DY 150, DY 692	1950	1900																																																																																					
Ø 60 mm	L (mm)	Ref.																																																																																					
DY 690	500 (2 pieces)	84887690																																																																																					
DY 691	1000 (2 pieces)	84887691																																																																																					
DY 692	1950 (2 pieces)	84887692																																																																																					
Ø 80 mm	L (mm)	Ref.																																																																																					
DY 613	250 (2 pieces)	84887613																																																																																					
DY 614	500 (2 pieces)	84887614																																																																																					
DY 615	1000 (2 pieces)	84887615																																																																																					
DY 150	1950 (2 pieces)	84887550																																																																																					
<p>Concentric inspection sleeve ⑦</p> 	<table border="1"> <thead> <tr> <th>Ø 60/100 mm</th> <th>Ref.</th> </tr> </thead> <tbody> <tr> <td>DY 689</td> <td>84887689</td> </tr> </tbody> </table>	Ø 60/100 mm	Ref.	DY 689	84887689	<p>Inspection sleeve single ④②</p>  <table border="1" data-bbox="837 795 1013 851"> <thead> <tr> <th></th> <th>A</th> <th>B</th> <th>C</th> </tr> </thead> <tbody> <tr> <td>DY 698</td> <td>250</td> <td>60</td> <td>130</td> </tr> <tr> <td>DY 146</td> <td>270</td> <td>75</td> <td>142</td> </tr> </tbody> </table> <table border="1"> <thead> <tr> <th>Ø 60 mm</th> <th>Ref.</th> </tr> </thead> <tbody> <tr> <td>DY 698</td> <td>84887698</td> </tr> </tbody> </table> <table border="1"> <thead> <tr> <th>Ø 80 mm</th> <th>Ref.</th> </tr> </thead> <tbody> <tr> <td>DY 146</td> <td>84887546</td> </tr> </tbody> </table>		A	B	C	DY 698	250	60	130	DY 146	270	75	142	Ø 60 mm	Ref.	DY 698	84887698	Ø 80 mm	Ref.	DY 146	84887546																																																													
Ø 60/100 mm	Ref.																																																																																						
DY 689	84887689																																																																																						
	A	B	C																																																																																				
DY 698	250	60	130																																																																																				
DY 146	270	75	142																																																																																				
Ø 60 mm	Ref.																																																																																						
DY 698	84887698																																																																																						
Ø 80 mm	Ref.																																																																																						
DY 146	84887546																																																																																						
<p>Concentric straight inspection pipe ⑦</p> 	<table border="1"> <thead> <tr> <th>Ø 80/125 mm</th> <th>Ref.</th> </tr> </thead> <tbody> <tr> <td>DY 124</td> <td>84887524</td> </tr> </tbody> </table>	Ø 80/125 mm	Ref.	DY 124	84887524	<p>Single inspection T ④④</p>  <table border="1" data-bbox="837 996 1013 1052"> <thead> <tr> <th></th> <th>A</th> <th>B</th> <th>C</th> </tr> </thead> <tbody> <tr> <td>DY 741</td> <td>251</td> <td>130</td> <td>100</td> </tr> <tr> <td>DY 163</td> <td>261</td> <td>142</td> <td>120</td> </tr> </tbody> </table> <table border="1"> <thead> <tr> <th>Ø 60 mm</th> <th>Ref.</th> </tr> </thead> <tbody> <tr> <td>DY 741</td> <td>84887741</td> </tr> </tbody> </table> <table border="1"> <thead> <tr> <th>Ø 80 mm</th> <th>Ref.</th> </tr> </thead> <tbody> <tr> <td>DY 163</td> <td>84887563</td> </tr> </tbody> </table>		A	B	C	DY 741	251	130	100	DY 163	261	142	120	Ø 60 mm	Ref.	DY 741	84887741	Ø 80 mm	Ref.	DY 163	84887563																																																													
Ø 80/125 mm	Ref.																																																																																						
DY 124	84887524																																																																																						
	A	B	C																																																																																				
DY 741	251	130	100																																																																																				
DY 163	261	142	120																																																																																				
Ø 60 mm	Ref.																																																																																						
DY 741	84887741																																																																																						
Ø 80 mm	Ref.																																																																																						
DY 163	84887563																																																																																						
<p>Concentric compensation sleeve ①⑦</p> 	<table border="1"> <thead> <tr> <th>Ø 60/100 mm</th> <th>Ref.</th> </tr> </thead> <tbody> <tr> <td>DY 688</td> <td>84887688</td> </tr> </tbody> </table> <table border="1"> <thead> <tr> <th>Ø 80/125 mm</th> <th>Ref.</th> </tr> </thead> <tbody> <tr> <td>DY 130</td> <td>84887530</td> </tr> </tbody> </table>	Ø 60/100 mm	Ref.	DY 688	84887688	Ø 80/125 mm	Ref.	DY 130	84887530	<p>Inspection elbow single ④⑤</p>  <table border="1"> <thead> <tr> <th>Ø 80 mm</th> <th>Ref.</th> </tr> </thead> <tbody> <tr> <td>DY 877</td> <td>100008301</td> </tr> </tbody> </table>	Ø 80 mm	Ref.	DY 877	100008301																																																																									
Ø 60/100 mm	Ref.																																																																																						
DY 688	84887688																																																																																						
Ø 80/125 mm	Ref.																																																																																						
DY 130	84887530																																																																																						
Ø 80 mm	Ref.																																																																																						
DY 877	100008301																																																																																						
<p>Concentric elbow at 87° ⑫</p> <table border="1" data-bbox="159 1310 391 1377"> <thead> <tr> <th></th> <th>A</th> <th>B</th> <th>C</th> <th>D</th> </tr> </thead> <tbody> <tr> <td>DY 684</td> <td>160</td> <td>162</td> <td>110</td> <td>120</td> </tr> <tr> <td>DY 131</td> <td>183</td> <td>185</td> <td>120</td> <td>130</td> </tr> </tbody> </table> <p>at 45°</p> <table border="1" data-bbox="159 1422 311 1489"> <thead> <tr> <th></th> <th>A</th> <th>B</th> </tr> </thead> <tbody> <tr> <td>DY 685</td> <td>70</td> <td>80</td> </tr> <tr> <td>DY 132</td> <td>90</td> <td>90</td> </tr> </tbody> </table> <p>at 30°</p>  <p>at 15°</p> 		A	B	C	D	DY 684	160	162	110	120	DY 131	183	185	120	130		A	B	DY 685	70	80	DY 132	90	90	<table border="1"> <thead> <tr> <th>Ø 60/100 mm</th> <th>Angle</th> <th>Ref.</th> </tr> </thead> <tbody> <tr> <td>DY 684</td> <td>87°</td> <td>84887684</td> </tr> <tr> <td>DY 685</td> <td>45° (2-pieces)</td> <td>84887685</td> </tr> <tr> <td>DY 686</td> <td>30° (2-pieces)</td> <td>84887686</td> </tr> <tr> <td>DY 687</td> <td>15° (2-pieces)</td> <td>84887687</td> </tr> </tbody> </table> <table border="1"> <thead> <tr> <th>Ø 80/125 mm</th> <th>Angle</th> <th>Ref.</th> </tr> </thead> <tbody> <tr> <td>DY 131</td> <td>87°</td> <td>84887531</td> </tr> <tr> <td>DY 132</td> <td>45° (2-pieces)</td> <td>84887532</td> </tr> </tbody> </table>	Ø 60/100 mm	Angle	Ref.	DY 684	87°	84887684	DY 685	45° (2-pieces)	84887685	DY 686	30° (2-pieces)	84887686	DY 687	15° (2-pieces)	84887687	Ø 80/125 mm	Angle	Ref.	DY 131	87°	84887531	DY 132	45° (2-pieces)	84887532	<p>Single elbow at 87° ④③</p>  <table border="1" data-bbox="837 1265 981 1321"> <thead> <tr> <th></th> <th>A</th> <th>B</th> </tr> </thead> <tbody> <tr> <td>DY 693</td> <td>120</td> <td>110</td> </tr> <tr> <td>DY 152</td> <td>130</td> <td>120</td> </tr> </tbody> </table> <p>at 45°</p>  <table border="1" data-bbox="837 1377 981 1433"> <thead> <tr> <th></th> <th>C</th> <th>D</th> </tr> </thead> <tbody> <tr> <td>DY 694</td> <td>80</td> <td>70</td> </tr> <tr> <td>DY 154</td> <td>90</td> <td>90</td> </tr> </tbody> </table> <table border="1"> <thead> <tr> <th>Ø 80 mm</th> <th>Angle</th> <th>Ref.</th> </tr> </thead> <tbody> <tr> <td>DY 693</td> <td>87°</td> <td>84887693</td> </tr> <tr> <td>DY 694</td> <td>45° (2-pieces)</td> <td>84887694</td> </tr> </tbody> </table> <table border="1"> <thead> <tr> <th>Ø 80 mm</th> <th>Angle</th> <th>Ref.</th> </tr> </thead> <tbody> <tr> <td>DY 152</td> <td>87°</td> <td>84887552</td> </tr> <tr> <td>DY 154</td> <td>45° (2-pieces)</td> <td>84887554</td> </tr> </tbody> </table>		A	B	DY 693	120	110	DY 152	130	120		C	D	DY 694	80	70	DY 154	90	90	Ø 80 mm	Angle	Ref.	DY 693	87°	84887693	DY 694	45° (2-pieces)	84887694	Ø 80 mm	Angle	Ref.	DY 152	87°	84887552	DY 154	45° (2-pieces)	84887554	
	A	B	C	D																																																																																			
DY 684	160	162	110	120																																																																																			
DY 131	183	185	120	130																																																																																			
	A	B																																																																																					
DY 685	70	80																																																																																					
DY 132	90	90																																																																																					
Ø 60/100 mm	Angle	Ref.																																																																																					
DY 684	87°	84887684																																																																																					
DY 685	45° (2-pieces)	84887685																																																																																					
DY 686	30° (2-pieces)	84887686																																																																																					
DY 687	15° (2-pieces)	84887687																																																																																					
Ø 80/125 mm	Angle	Ref.																																																																																					
DY 131	87°	84887531																																																																																					
DY 132	45° (2-pieces)	84887532																																																																																					
	A	B																																																																																					
DY 693	120	110																																																																																					
DY 152	130	120																																																																																					
	C	D																																																																																					
DY 694	80	70																																																																																					
DY 154	90	90																																																																																					
Ø 80 mm	Angle	Ref.																																																																																					
DY 693	87°	84887693																																																																																					
DY 694	45° (2-pieces)	84887694																																																																																					
Ø 80 mm	Angle	Ref.																																																																																					
DY 152	87°	84887552																																																																																					
DY 154	45° (2-pieces)	84887554																																																																																					
<p>Concentric inspection T ⑧</p>  <table border="1" data-bbox="159 1870 343 1926"> <thead> <tr> <th></th> <th>A</th> <th>B</th> <th>C</th> </tr> </thead> <tbody> <tr> <td>DY 737</td> <td>250</td> <td>120</td> <td>100</td> </tr> <tr> <td>DY 125</td> <td>270</td> <td>130</td> <td>120</td> </tr> </tbody> </table>		A	B	C	DY 737	250	120	100	DY 125	270	130	120	<table border="1"> <thead> <tr> <th>Ø 60/100 mm</th> <th>Ref.</th> </tr> </thead> <tbody> <tr> <td>DY 737</td> <td>84887737</td> </tr> </tbody> </table> <table border="1"> <thead> <tr> <th>Ø 80/125 mm</th> <th>Ref.</th> </tr> </thead> <tbody> <tr> <td>DY 125</td> <td>84887525</td> </tr> </tbody> </table>	Ø 60/100 mm	Ref.	DY 737	84887737	Ø 80/125 mm	Ref.	DY 125	84887525	<p>Centering star ②</p>  <table border="1" data-bbox="837 1568 925 1624"> <thead> <tr> <th></th> <th>B</th> </tr> </thead> <tbody> <tr> <td>DY 673</td> <td>60</td> </tr> <tr> <td>DY 151</td> <td>80</td> </tr> </tbody> </table> <table border="1"> <thead> <tr> <th>Ø 60 mm</th> <th>Ref.</th> </tr> </thead> <tbody> <tr> <td>DY 673 (12 pieces)</td> <td>84887673</td> </tr> </tbody> </table> <table border="1"> <thead> <tr> <th>Ø 80 mm</th> <th>Ref.</th> </tr> </thead> <tbody> <tr> <td>DY 151 (12 pieces)</td> <td>84887563</td> </tr> </tbody> </table>		B	DY 673	60	DY 151	80	Ø 60 mm	Ref.	DY 673 (12 pieces)	84887673	Ø 80 mm	Ref.	DY 151 (12 pieces)	84887563																																																			
	A	B	C																																																																																				
DY 737	250	120	100																																																																																				
DY 125	270	130	120																																																																																				
Ø 60/100 mm	Ref.																																																																																						
DY 737	84887737																																																																																						
Ø 80/125 mm	Ref.																																																																																						
DY 125	84887525																																																																																						
	B																																																																																						
DY 673	60																																																																																						
DY 151	80																																																																																						
Ø 60 mm	Ref.																																																																																						
DY 673 (12 pieces)	84887673																																																																																						
Ø 80 mm	Ref.																																																																																						
DY 151 (12 pieces)	84887563																																																																																						
<p>Concentric inspection elbow ②③</p> 	<table border="1"> <thead> <tr> <th>Ø 80/125 mm</th> <th>Ref.</th> </tr> </thead> <tbody> <tr> <td>DY 875</td> <td>100008311</td> </tr> </tbody> </table>	Ø 80/125 mm	Ref.	DY 875	100008311	<p>Air/flue gas vent with flashing ①</p>  <table border="1"> <thead> <tr> <th>Ø 80 mm</th> <th>Ref.</th> </tr> </thead> <tbody> <tr> <td>DY 185</td> <td>84887585</td> </tr> </tbody> </table>	Ø 80 mm	Ref.	DY 185	84887585	<p>Stainless steel protection screen for roof outlet ③④</p>  <table border="1"> <thead> <tr> <th>Ø 90 mm</th> <th>Ref.</th> </tr> </thead> <tbody> <tr> <td>-</td> <td>30000712</td> </tr> </tbody> </table>	Ø 90 mm	Ref.	-	30000712																																																																								
Ø 80/125 mm	Ref.																																																																																						
DY 875	100008311																																																																																						
Ø 80 mm	Ref.																																																																																						
DY 185	84887585																																																																																						
Ø 90 mm	Ref.																																																																																						
-	30000712																																																																																						

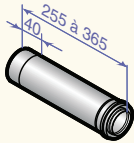
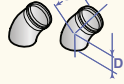
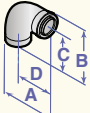
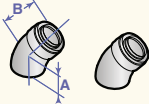
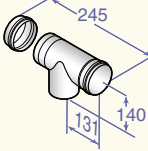
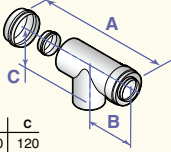
IN BOILER ROOM, SINGLE "RIGID" PPS PIPES IN CHIMNEY

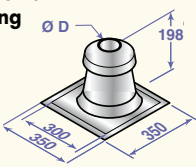
⇒ Other Alu/PPS and single PPS flue systems accessories available:

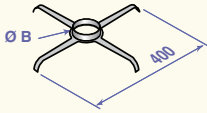
<p>Concentric extension</p>  <table border="1" data-bbox="165 488 402 589"> <thead> <tr> <th></th> <th>A</th> <th>B</th> </tr> </thead> <tbody> <tr> <td>DY 126</td> <td>250</td> <td>200</td> </tr> <tr> <td>DY 811, DY 127</td> <td>500</td> <td>450</td> </tr> <tr> <td>DY 812, DY 128</td> <td>1000</td> <td>950</td> </tr> <tr> <td>DY 129</td> <td>1950</td> <td>1900</td> </tr> </tbody> </table>		A	B	DY 126	250	200	DY 811, DY 127	500	450	DY 812, DY 128	1000	950	DY 129	1950	1900	<p>⑪</p> <table border="1"> <thead> <tr> <th>Ø 80/125 mm</th> <th>L (mm)</th> <th>Ref.</th> </tr> </thead> <tbody> <tr> <td>DY 126</td> <td>250</td> <td>84887526</td> </tr> <tr> <td>DY 127</td> <td>500</td> <td>84887527</td> </tr> <tr> <td>DY 128</td> <td>1000</td> <td>84887528</td> </tr> <tr> <td>DY 129</td> <td>1950</td> <td>84887529</td> </tr> </tbody> </table> <table border="1"> <thead> <tr> <th>Ø 110/150 mm</th> <th>L (mm)</th> <th>Ref.</th> </tr> </thead> <tbody> <tr> <td>DY 811</td> <td>500</td> <td>100002351</td> </tr> <tr> <td>DY 812</td> <td>1000</td> <td>100002352</td> </tr> </tbody> </table>	Ø 80/125 mm	L (mm)	Ref.	DY 126	250	84887526	DY 127	500	84887527	DY 128	1000	84887528	DY 129	1950	84887529	Ø 110/150 mm	L (mm)	Ref.	DY 811	500	100002351	DY 812	1000	100002352	<p>Single extension</p>  <table border="1" data-bbox="852 454 1088 555"> <thead> <tr> <th></th> <th>A</th> <th>B</th> </tr> </thead> <tbody> <tr> <td>DY 613</td> <td>250</td> <td>200</td> </tr> <tr> <td>DY 614, DY 180</td> <td>500</td> <td>450</td> </tr> <tr> <td>DY 615, DY 179</td> <td>1000</td> <td>950</td> </tr> <tr> <td>DY 150, DY 178</td> <td>1950</td> <td>1900</td> </tr> </tbody> </table>		A	B	DY 613	250	200	DY 614, DY 180	500	450	DY 615, DY 179	1000	950	DY 150, DY 178	1950	1900	<p>⑥</p> <table border="1"> <thead> <tr> <th>Ø 80 mm</th> <th>L (mm)</th> <th>Ref.</th> </tr> </thead> <tbody> <tr> <td>DY 613</td> <td>250 (2 pieces)</td> <td>84887613</td> </tr> <tr> <td>DY 614</td> <td>500 (2 pieces)</td> <td>84887614</td> </tr> <tr> <td>DY 615</td> <td>1000 (2 pieces)</td> <td>84887615</td> </tr> <tr> <td>DY 150</td> <td>1950 (2 pieces)</td> <td>84887550</td> </tr> </tbody> </table> <table border="1"> <thead> <tr> <th>Ø 110 mm</th> <th>L (mm)</th> <th>Ref.</th> </tr> </thead> <tbody> <tr> <td>DY 180</td> <td>500</td> <td>84887580</td> </tr> <tr> <td>DY 179</td> <td>1000</td> <td>84887581</td> </tr> <tr> <td>DY 178</td> <td>1950</td> <td>84887578</td> </tr> </tbody> </table>	Ø 80 mm	L (mm)	Ref.	DY 613	250 (2 pieces)	84887613	DY 614	500 (2 pieces)	84887614	DY 615	1000 (2 pieces)	84887615	DY 150	1950 (2 pieces)	84887550	Ø 110 mm	L (mm)	Ref.	DY 180	500	84887580	DY 179	1000	84887581	DY 178	1950	84887578
	A	B																																																																																		
DY 126	250	200																																																																																		
DY 811, DY 127	500	450																																																																																		
DY 812, DY 128	1000	950																																																																																		
DY 129	1950	1900																																																																																		
Ø 80/125 mm	L (mm)	Ref.																																																																																		
DY 126	250	84887526																																																																																		
DY 127	500	84887527																																																																																		
DY 128	1000	84887528																																																																																		
DY 129	1950	84887529																																																																																		
Ø 110/150 mm	L (mm)	Ref.																																																																																		
DY 811	500	100002351																																																																																		
DY 812	1000	100002352																																																																																		
	A	B																																																																																		
DY 613	250	200																																																																																		
DY 614, DY 180	500	450																																																																																		
DY 615, DY 179	1000	950																																																																																		
DY 150, DY 178	1950	1900																																																																																		
Ø 80 mm	L (mm)	Ref.																																																																																		
DY 613	250 (2 pieces)	84887613																																																																																		
DY 614	500 (2 pieces)	84887614																																																																																		
DY 615	1000 (2 pieces)	84887615																																																																																		
DY 150	1950 (2 pieces)	84887550																																																																																		
Ø 110 mm	L (mm)	Ref.																																																																																		
DY 180	500	84887580																																																																																		
DY 179	1000	84887581																																																																																		
DY 178	1950	84887578																																																																																		
<p>Concentric staight inspection pipe</p> 	<p>⑦</p> <table border="1"> <thead> <tr> <th>Ø 80/125 mm</th> <th>Ref.</th> </tr> </thead> <tbody> <tr> <td>DY 124</td> <td>84887524</td> </tr> </tbody> </table>	Ø 80/125 mm	Ref.	DY 124	84887524	<p>Single inspection sleeve</p> 	<p>④2</p> <table border="1"> <thead> <tr> <th>Ø 80 mm</th> <th>Ref.</th> </tr> </thead> <tbody> <tr> <td>DY 146</td> <td>84887546</td> </tr> </tbody> </table>	Ø 80 mm	Ref.	DY 146	84887546																																																																									
Ø 80/125 mm	Ref.																																																																																			
DY 124	84887524																																																																																			
Ø 80 mm	Ref.																																																																																			
DY 146	84887546																																																																																			
<p>Concentric inspection sleeve</p> 	<p>⑦</p> <table border="1"> <thead> <tr> <th>Ø 110/150 mm</th> <th>Ref.</th> </tr> </thead> <tbody> <tr> <td>DY 815</td> <td>100002355</td> </tr> </tbody> </table>	Ø 110/150 mm	Ref.	DY 815	100002355	<p>Single elbow at 87°</p>  <table border="1" data-bbox="847 958 991 1014"> <thead> <tr> <th></th> <th>A</th> <th>B</th> </tr> </thead> <tbody> <tr> <td>DY 152</td> <td>130</td> <td>120</td> </tr> <tr> <td>DY 181</td> <td>120</td> <td>120</td> </tr> </tbody> </table>		A	B	DY 152	130	120	DY 181	120	120	<p>④3</p> <table border="1"> <thead> <tr> <th>Ø 80 mm</th> <th>Angle</th> <th>Ref.</th> </tr> </thead> <tbody> <tr> <td>DY 152</td> <td>87°</td> <td>84887552</td> </tr> <tr> <td>DY 154</td> <td>45° (2-pieces)</td> <td>84887554</td> </tr> </tbody> </table>	Ø 80 mm	Angle	Ref.	DY 152	87°	84887552	DY 154	45° (2-pieces)	84887554																																																											
Ø 110/150 mm	Ref.																																																																																			
DY 815	100002355																																																																																			
	A	B																																																																																		
DY 152	130	120																																																																																		
DY 181	120	120																																																																																		
Ø 80 mm	Angle	Ref.																																																																																		
DY 152	87°	84887552																																																																																		
DY 154	45° (2-pieces)	84887554																																																																																		
<p>Concentric compensation concentric</p> 	<p>⑰</p> <table border="1"> <thead> <tr> <th>Ø 80/125 mm</th> <th>Ref.</th> </tr> </thead> <tbody> <tr> <td>DY 130</td> <td>84887530</td> </tr> </tbody> </table>	Ø 80/125 mm	Ref.	DY 130	84887530	<p>at 45°</p>  <table border="1" data-bbox="847 1126 991 1182"> <thead> <tr> <th></th> <th>C</th> <th>D</th> </tr> </thead> <tbody> <tr> <td>DY 154</td> <td>90</td> <td>90</td> </tr> <tr> <td>DY 182</td> <td>90</td> <td>90</td> </tr> </tbody> </table>		C	D	DY 154	90	90	DY 182	90	90	<table border="1"> <thead> <tr> <th>Ø 110 mm</th> <th>Angle</th> <th>Ref.</th> </tr> </thead> <tbody> <tr> <td>DY 181</td> <td>87°</td> <td>84887581</td> </tr> <tr> <td>DY 182</td> <td>45° (2-pieces)</td> <td>84887582</td> </tr> </tbody> </table>	Ø 110 mm	Angle	Ref.	DY 181	87°	84887581	DY 182	45° (2-pieces)	84887582																																																											
Ø 80/125 mm	Ref.																																																																																			
DY 130	84887530																																																																																			
	C	D																																																																																		
DY 154	90	90																																																																																		
DY 182	90	90																																																																																		
Ø 110 mm	Angle	Ref.																																																																																		
DY 181	87°	84887581																																																																																		
DY 182	45° (2-pieces)	84887582																																																																																		
<p>Concentric elbow at 87°</p>  <table border="1" data-bbox="165 1406 395 1462"> <thead> <tr> <th></th> <th>A</th> <th>B</th> <th>C</th> <th>D</th> </tr> </thead> <tbody> <tr> <td>DY 813</td> <td>239</td> <td>241</td> <td>165</td> <td>164</td> </tr> <tr> <td>DY 131</td> <td>183</td> <td>185</td> <td>120</td> <td>130</td> </tr> </tbody> </table> <p>at 45°</p>  <table border="1" data-bbox="165 1608 309 1664"> <thead> <tr> <th></th> <th>A</th> <th>B</th> </tr> </thead> <tbody> <tr> <td>DY 132</td> <td>90</td> <td>90</td> </tr> <tr> <td>DY 814</td> <td>110</td> <td>110</td> </tr> </tbody> </table>		A	B	C	D	DY 813	239	241	165	164	DY 131	183	185	120	130		A	B	DY 132	90	90	DY 814	110	110	<p>⑫</p> <table border="1"> <thead> <tr> <th>Ø 80/125 mm</th> <th>Angle</th> <th>Ref.</th> </tr> </thead> <tbody> <tr> <td>DY 131</td> <td>87°</td> <td>84887531</td> </tr> <tr> <td>DY 132</td> <td>45° (2-pieces)</td> <td>84887532</td> </tr> </tbody> </table> <table border="1"> <thead> <tr> <th>Ø 110/150 mm</th> <th>Angle</th> <th>Ref.</th> </tr> </thead> <tbody> <tr> <td>DY 813</td> <td>87°</td> <td>100002353</td> </tr> <tr> <td>DY 814</td> <td>45° (2-pieces)</td> <td>100002354</td> </tr> </tbody> </table>	Ø 80/125 mm	Angle	Ref.	DY 131	87°	84887531	DY 132	45° (2-pieces)	84887532	Ø 110/150 mm	Angle	Ref.	DY 813	87°	100002353	DY 814	45° (2-pieces)	100002354	<p>Inspection T single</p> 	<p>④4</p> <table border="1"> <thead> <tr> <th>Ø 80 mm</th> <th>Ref.</th> </tr> </thead> <tbody> <tr> <td>DY 163</td> <td>84887563</td> </tr> </tbody> </table> <table border="1"> <thead> <tr> <th>Ø 110 mm</th> <th>Ref.</th> </tr> </thead> <tbody> <tr> <td>DY 183</td> <td>84887583</td> </tr> </tbody> </table>	Ø 80 mm	Ref.	DY 163	84887563	Ø 110 mm	Ref.	DY 183	84887583																															
	A	B	C	D																																																																																
DY 813	239	241	165	164																																																																																
DY 131	183	185	120	130																																																																																
	A	B																																																																																		
DY 132	90	90																																																																																		
DY 814	110	110																																																																																		
Ø 80/125 mm	Angle	Ref.																																																																																		
DY 131	87°	84887531																																																																																		
DY 132	45° (2-pieces)	84887532																																																																																		
Ø 110/150 mm	Angle	Ref.																																																																																		
DY 813	87°	100002353																																																																																		
DY 814	45° (2-pieces)	100002354																																																																																		
Ø 80 mm	Ref.																																																																																			
DY 163	84887563																																																																																			
Ø 110 mm	Ref.																																																																																			
DY 183	84887583																																																																																			
<p>Inspection T concentric</p>  <table border="1" data-bbox="165 1832 341 1888"> <thead> <tr> <th></th> <th>A</th> <th>B</th> <th>C</th> </tr> </thead> <tbody> <tr> <td>DY 125</td> <td>270</td> <td>140</td> <td>120</td> </tr> <tr> <td>DY 816</td> <td>270</td> <td>120</td> <td>140</td> </tr> </tbody> </table>		A	B	C	DY 125	270	140	120	DY 816	270	120	140	<p>⑧</p> <table border="1"> <thead> <tr> <th>Ø 80/125 mm</th> <th>Ref.</th> </tr> </thead> <tbody> <tr> <td>DY 125</td> <td>84887525</td> </tr> </tbody> </table> <table border="1"> <thead> <tr> <th>Ø 110/150 mm</th> <th>Ref.</th> </tr> </thead> <tbody> <tr> <td>DY 816</td> <td>100002356</td> </tr> </tbody> </table>	Ø 80/125 mm	Ref.	DY 125	84887525	Ø 110/150 mm	Ref.	DY 816	100002356	<p>Inspection elbow single</p>  <table border="1" data-bbox="847 1485 991 1541"> <thead> <tr> <th></th> <th>A</th> <th>B</th> </tr> </thead> <tbody> <tr> <td>DY 877</td> <td>130</td> <td>120</td> </tr> <tr> <td>DY 188</td> <td>120</td> <td>120</td> </tr> </tbody> </table>		A	B	DY 877	130	120	DY 188	120	120	<p>④5</p> <table border="1"> <thead> <tr> <th>Ø 80 mm</th> <th>Ref.</th> </tr> </thead> <tbody> <tr> <td>DY 877</td> <td>100008301</td> </tr> </tbody> </table> <table border="1"> <thead> <tr> <th>Ø 110 mm</th> <th>Ref.</th> </tr> </thead> <tbody> <tr> <td>DY 188</td> <td>84887588</td> </tr> </tbody> </table>	Ø 80 mm	Ref.	DY 877	100008301	Ø 110 mm	Ref.	DY 188	84887588																																												
	A	B	C																																																																																	
DY 125	270	140	120																																																																																	
DY 816	270	120	140																																																																																	
Ø 80/125 mm	Ref.																																																																																			
DY 125	84887525																																																																																			
Ø 110/150 mm	Ref.																																																																																			
DY 816	100002356																																																																																			
	A	B																																																																																		
DY 877	130	120																																																																																		
DY 188	120	120																																																																																		
Ø 80 mm	Ref.																																																																																			
DY 877	100008301																																																																																			
Ø 110 mm	Ref.																																																																																			
DY 188	84887588																																																																																			
<p>Inspection elbow concentric</p> 	<p>⑳</p> <table border="1"> <thead> <tr> <th>Ø 80/125 mm</th> <th>Ref.</th> </tr> </thead> <tbody> <tr> <td>DY 875</td> <td>100008311</td> </tr> </tbody> </table>	Ø 80/125 mm	Ref.	DY 875	100008311	<p>Air/flue gas vent with flashing</p>  <table border="1" data-bbox="847 1686 932 1742"> <thead> <tr> <th></th> <th>D</th> </tr> </thead> <tbody> <tr> <td>DY 185</td> <td>80</td> </tr> <tr> <td>DY 189</td> <td>110</td> </tr> </tbody> </table>		D	DY 185	80	DY 189	110	<p>①</p> <table border="1"> <thead> <tr> <th>Ø 80 mm</th> <th>Ref.</th> </tr> </thead> <tbody> <tr> <td>DY 185</td> <td>84887585</td> </tr> </tbody> </table> <table border="1"> <thead> <tr> <th>Ø 110 mm</th> <th>Ref.</th> </tr> </thead> <tbody> <tr> <td>DY 189</td> <td>84887589</td> </tr> </tbody> </table>	Ø 80 mm	Ref.	DY 185	84887585	Ø 110 mm	Ref.	DY 189	84887589																																																															
Ø 80/125 mm	Ref.																																																																																			
DY 875	100008311																																																																																			
	D																																																																																			
DY 185	80																																																																																			
DY 189	110																																																																																			
Ø 80 mm	Ref.																																																																																			
DY 185	84887585																																																																																			
Ø 110 mm	Ref.																																																																																			
DY 189	84887589																																																																																			
<p>Stainless steel protection screen for roof outlet</p> 		<p>③4</p> 	<table border="1"> <thead> <tr> <th>Ø 90 mm</th> <th>Ref.</th> </tr> </thead> <tbody> <tr> <td>-</td> <td>300007172</td> </tr> </tbody> </table> <table border="1"> <thead> <tr> <th>Ø 120 mm</th> <th>Ref.</th> </tr> </thead> <tbody> <tr> <td>-</td> <td>300007173</td> </tr> </tbody> </table>	Ø 90 mm	Ref.	-	300007172	Ø 120 mm	Ref.	-	300007173																																																																									
Ø 90 mm	Ref.																																																																																			
-	300007172																																																																																			
Ø 120 mm	Ref.																																																																																			
-	300007173																																																																																			
		<p>Centering star</p>  <table border="1" data-bbox="847 2022 932 2078"> <thead> <tr> <th></th> <th>B</th> </tr> </thead> <tbody> <tr> <td>DY 151</td> <td>80</td> </tr> <tr> <td>DY 187</td> <td>110</td> </tr> </tbody> </table>		B	DY 151	80	DY 187	110	<p>②</p> <table border="1"> <thead> <tr> <th>Ø 80 mm</th> <th>Ref.</th> </tr> </thead> <tbody> <tr> <td>DY 151 (2 pieces)</td> <td>84887551</td> </tr> </tbody> </table> <table border="1"> <thead> <tr> <th>Ø 110 mm</th> <th>Ref.</th> </tr> </thead> <tbody> <tr> <td>DY 187 (2 pieces)</td> <td>84887587</td> </tr> </tbody> </table>	Ø 80 mm	Ref.	DY 151 (2 pieces)	84887551	Ø 110 mm	Ref.	DY 187 (2 pieces)	84887587																																																																			
	B																																																																																			
DY 151	80																																																																																			
DY 187	110																																																																																			
Ø 80 mm	Ref.																																																																																			
DY 151 (2 pieces)	84887551																																																																																			
Ø 110 mm	Ref.																																																																																			
DY 187 (2 pieces)	84887587																																																																																			