

1 ПОДСОЕДИНЕНИЕ С_{13x} - ГОРИЗОНТАЛЬНЫЙ КОАКСИАЛЬНЫЙ ДЫМОХОД AL/PPS (ВЫХОД ЧЕРЕЗ НАРУЖНУЮ СТЕНУ ИЛИ КРЫШУ)

INNOVENS и INNOVENS PRO MCA

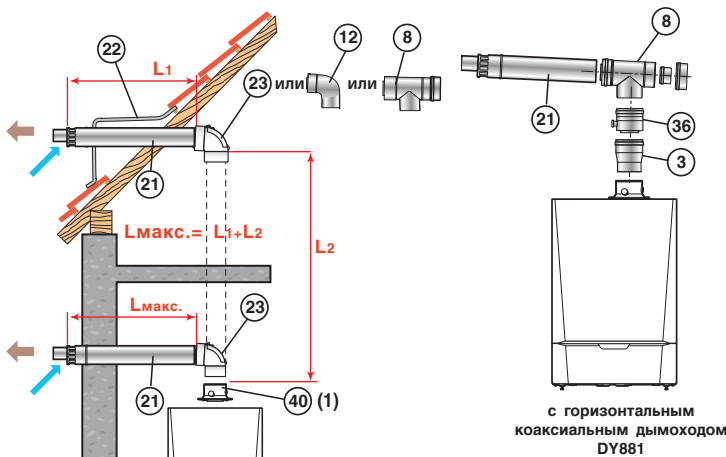

На рисунке показан котёл MCA с горизонтальным коаксиальным дымоходом \varnothing 80/125 мм (ед. поставки DY 882) + Переходник \varnothing 80/125 мм (ед. поставки HR 38)

(1) или, если необходимо, позиция 3

Тип котла	\varnothing подсоединения, мм	L _{макс} , м		
		60/100	80/125	110/150
INNOVENS PRO MCA 45		-	16	-
INNOVENS PRO MCA 65		-	-	9
INNOVENS PRO MCA 90		-	-	8
INNOVENS PRO MCA 115		-	-	5,9
INNOVENS MCA 15		12	12,3	-
INNOVENS MCA 25		3,5	20	-
INNOVENS MCA 35		3,5	17,6	-
INNOVENS MCA 25/28 MI		4,2	20	-
INNOVENS MCA 25/28 BIC		4,2	20	-

\varnothing подсоединения, мм	Эквивалентная длина, м		
	60/100	80/125	110/150
Колено 87°	1,1	1,5	3,7
Колено 45°	0,8	1,0	1,0
Колено 30°	0,7	-	-
Колено 15°	0,5	-	-
Труба с лючком для ревизии	0,5	0,6	1,0
Тройник с лючком для ревизии	2,2	2,7	2,5
Колено с лючком для ревизии	-	2,0	-
Сборник конденсата	-	0,8	0,6





⇒ **Минимальное** количество принадлежностей дымоходов (Al/PPS) для подсоединения к горизонтальному коаксиальному дымоходу :

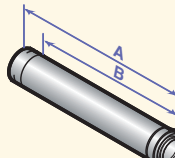

Наименование	Чертеж с размерами и обозначением позиций	Тип котла	INNOVENS PRO MCA 45 - 115		INNOVENS MCA 15, 25, 35, 25/28 MI, 25/28 BIC	
			45	65, 90, 115	60/100	80/125
			\varnothing подсоединения, мм	80/125	110/150	60/100
Горизонтальный коаксиальный дымоход \varnothing 80/125 мм и колено с лючком для ревизии		DY 882 100011365	X			X
Горизонтальный коаксиальный дымоход \varnothing 110/150 мм, тройник с лючком для ревизии и переходник с \varnothing 100/150 на \varnothing 110/150 мм		DY 881 100011364		X		
Горизонтальный коаксиальный дымоход \varnothing 60/100 мм и колено с лючком для ревизии		HR 48 100013756			X (1)	
Уменьшенное колено \varnothing 60/100 мм		JA 43 100018253			X (2)	
Сборник конденсата \varnothing 80/125 мм		DY 916 100018981	X			
Сборник конденсата \varnothing 110/150		DY 918 100018984		X		
Переходник \varnothing 80/125 мм		HR 38 S 100465				X

(1) Поставляется вместе с котлом при заказе с соответствующим горизонтальным коаксиальным дымоходом

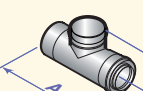
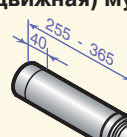
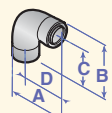
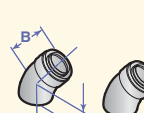
(2) Для смещения оси коаксиального дымохода на **70 мм** вниз (для замены колена, поставляемого с HR 48). После удаления существующего патрубка дымохода крепится винтами непосредственно на котёл.

⇒ Другие принадлежности для коаксиального дымохода (Al/PPS) :

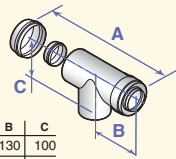
Коаксиальное удлинение 	11	<table border="1"> <tr> <th>∅60/100 мм</th> <th>Длина, мм</th> <th>Арт.</th> </tr> <tr> <td>DY 681</td> <td>500</td> <td>84887681</td> </tr> <tr> <td>DY 682</td> <td>1000</td> <td>84887682</td> </tr> <tr> <td>DY 683</td> <td>1950</td> <td>84887683</td> </tr> </table>	∅60/100 мм	Длина, мм	Арт.	DY 681	500	84887681	DY 682	1000	84887682	DY 683	1950	84887683	<table border="1"> <tr> <th>∅80/125 мм</th> <th>Длина, мм</th> <th>Арт.</th> </tr> <tr> <td>DY 126</td> <td>250</td> <td>84887526</td> </tr> <tr> <td>DY 127</td> <td>500</td> <td>84887527</td> </tr> <tr> <td>DY 128</td> <td>1000</td> <td>84887528</td> </tr> <tr> <td>DY 129</td> <td>1950</td> <td>84887529</td> </tr> </table>	∅80/125 мм	Длина, мм	Арт.	DY 126	250	84887526	DY 127	500	84887527	DY 128	1000	84887528	DY 129	1950	84887529
		∅60/100 мм	Длина, мм	Арт.																										
DY 681	500	84887681																												
DY 682	1000	84887682																												
DY 683	1950	84887683																												
∅80/125 мм	Длина, мм	Арт.																												
DY 126	250	84887526																												
DY 127	500	84887527																												
DY 128	1000	84887528																												
DY 129	1950	84887529																												
<table border="1"> <tr> <td>DY 126</td> <td>A</td> <td>B</td> </tr> <tr> <td></td> <td>250</td> <td>200</td> </tr> <tr> <td>DY 681, DY 127</td> <td>500</td> <td>450</td> </tr> <tr> <td>DY 682, DY 128</td> <td>1000</td> <td>950</td> </tr> <tr> <td>DY 683, DY 129</td> <td>1950</td> <td>1900</td> </tr> </table>	DY 126	A	B		250	200	DY 681, DY 127	500	450	DY 682, DY 128	1000	950	DY 683, DY 129	1950	1900															
DY 126	A	B																												
	250	200																												
DY 681, DY 127	500	450																												
DY 682, DY 128	1000	950																												
DY 683, DY 129	1950	1900																												
Прямая коаксиальная труба с лючком для ревизии 	7	<table border="1"> <tr> <th>∅80/125 мм</th> <th>Арт.</th> </tr> <tr> <td>DY 124</td> <td>84887524</td> </tr> </table>	∅80/125 мм	Арт.	DY 124	84887524																								
∅80/125 мм	Арт.																													
DY 124	84887524																													
Коаксиальная муфта с лючком для ревизии 	7	<table border="1"> <tr> <th>∅60/100 мм</th> <th>Арт.</th> </tr> <tr> <td>DY 689</td> <td>84887689</td> </tr> </table>	∅60/100 мм	Арт.	DY 689	84887689																								
∅60/100 мм	Арт.																													
DY 689	84887689																													
<table border="1"> <tr> <td>DY 689</td> <td>A</td> <td>B</td> </tr> <tr> <td></td> <td>250</td> <td>100</td> </tr> <tr> <td>DY 815</td> <td>270</td> <td>140</td> </tr> </table>	DY 689	A	B		250	100	DY 815	270	140																					
DY 689	A	B																												
	250	100																												
DY 815	270	140																												
Коаксиальная компенсационная (раздвижная) муфта 	17	<table border="1"> <tr> <td>DY 688</td> <td>∅60/100 мм</td> <td>84887688</td> </tr> <tr> <td>DY 130</td> <td>∅80/125 мм</td> <td>84887530</td> </tr> </table>	DY 688	∅60/100 мм	84887688	DY 130	∅80/125 мм	84887530																						
DY 688	∅60/100 мм	84887688																												
DY 130	∅80/125 мм	84887530																												
Коаксиальное колено : 87° 	12	<table border="1"> <tr> <th>∅60/100 мм</th> <th>Угол</th> <th>Арт.</th> </tr> <tr> <td>DY 684</td> <td>87°</td> <td>84887684</td> </tr> <tr> <td>DY 685</td> <td>45° (2 шт.)</td> <td>84887685</td> </tr> <tr> <td>DY 686</td> <td>30° (2 шт.)</td> <td>84887686</td> </tr> <tr> <td>DY 687</td> <td>15° (2 шт.)</td> <td>84887687</td> </tr> </table>	∅60/100 мм	Угол	Арт.	DY 684	87°	84887684	DY 685	45° (2 шт.)	84887685	DY 686	30° (2 шт.)	84887686	DY 687	15° (2 шт.)	84887687													
∅60/100 мм	Угол	Арт.																												
DY 684	87°	84887684																												
DY 685	45° (2 шт.)	84887685																												
DY 686	30° (2 шт.)	84887686																												
DY 687	15° (2 шт.)	84887687																												
<table border="1"> <tr> <td>DY 684</td> <td>A</td> <td>B</td> <td>C</td> <td>D</td> </tr> <tr> <td></td> <td>170</td> <td>162</td> <td>110</td> <td>120</td> </tr> <tr> <td>DY 131</td> <td>193</td> <td>185</td> <td>120</td> <td>130</td> </tr> <tr> <td>DY 813</td> <td>239</td> <td>241</td> <td>165</td> <td>164</td> </tr> </table>	DY 684	A	B	C	D		170	162	110	120	DY 131	193	185	120	130	DY 813	239	241	165	164										
DY 684	A	B	C	D																										
	170	162	110	120																										
DY 131	193	185	120	130																										
DY 813	239	241	165	164																										
45° 		<table border="1"> <tr> <th>∅80/125 мм</th> <th>Угол</th> <th>Арт.</th> </tr> <tr> <td>DY 131</td> <td>87°</td> <td>84887531</td> </tr> <tr> <td>DY 132</td> <td>45° (2 шт.)</td> <td>84887532</td> </tr> </table>	∅80/125 мм	Угол	Арт.	DY 131	87°	84887531	DY 132	45° (2 шт.)	84887532																			
∅80/125 мм	Угол	Арт.																												
DY 131	87°	84887531																												
DY 132	45° (2 шт.)	84887532																												
<table border="1"> <tr> <td>DY 685</td> <td>A</td> <td>B</td> </tr> <tr> <td></td> <td>70</td> <td>80</td> </tr> <tr> <td>DY 132</td> <td>90</td> <td>90</td> </tr> <tr> <td>DY 814</td> <td>110</td> <td>110</td> </tr> </table>	DY 685	A	B		70	80	DY 132	90	90	DY 814	110	110																		
DY 685	A	B																												
	70	80																												
DY 132	90	90																												
DY 814	110	110																												
30° 		<table border="1"> <tr> <th>∅110/150 мм</th> <th>Угол</th> <th>Арт.</th> </tr> <tr> <td>DY 813</td> <td>87°</td> <td>100002353</td> </tr> <tr> <td>DY 814</td> <td>45° (2 шт.)</td> <td>100002354</td> </tr> </table>	∅110/150 мм	Угол	Арт.	DY 813	87°	100002353	DY 814	45° (2 шт.)	100002354																			
∅110/150 мм	Угол	Арт.																												
DY 813	87°	100002353																												
DY 814	45° (2 шт.)	100002354																												
<table border="1"> <tr> <td>DY 813</td> <td>A</td> <td>B</td> </tr> <tr> <td></td> <td>85</td> <td>85</td> </tr> <tr> <td>DY 814</td> <td>85</td> <td>85</td> </tr> </table>	DY 813	A	B		85	85	DY 814	85	85																					
DY 813	A	B																												
	85	85																												
DY 814	85	85																												
15° 																														
<table border="1"> <tr> <td>DY 814</td> <td>A</td> <td>B</td> </tr> <tr> <td></td> <td>85</td> <td>85</td> </tr> </table>	DY 814	A	B		85	85																								
DY 814	A	B																												
	85	85																												

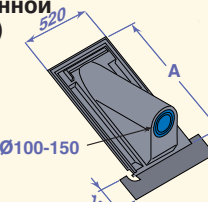
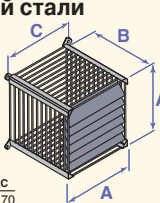
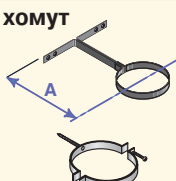
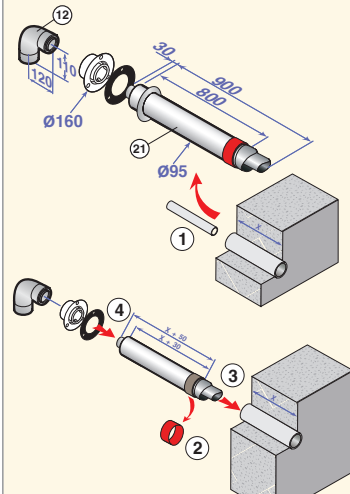
Коаксиальный тройник с лючком для ревизии 	8	<table border="1"> <tr> <th>∅60/100 мм</th> <th>Арт.</th> </tr> <tr> <td>DY 737</td> <td>84887737</td> </tr> </table>	∅60/100 мм	Арт.	DY 737	84887737													
∅60/100 мм	Арт.																		
DY 737	84887737																		
<table border="1"> <tr> <td>DY 737</td> <td>A</td> <td>B</td> <td>C</td> </tr> <tr> <td></td> <td>250</td> <td>130</td> <td>100</td> </tr> <tr> <td>DY 125</td> <td>270</td> <td>140</td> <td>120</td> </tr> <tr> <td>DY 816</td> <td>270</td> <td>120</td> <td>140</td> </tr> </table>	DY 737	A	B	C		250	130	100	DY 125	270	140	120	DY 816	270	120	140			
DY 737	A	B	C																
	250	130	100																
DY 125	270	140	120																
DY 816	270	120	140																
<table border="1"> <tr> <th>∅80/125 мм</th> <th>Арт.</th> </tr> <tr> <td>DY 125</td> <td>84887525</td> </tr> </table>	∅80/125 мм	Арт.	DY 125	84887525															
∅80/125 мм	Арт.																		
DY 125	84887525																		
<table border="1"> <tr> <th>∅110/150 мм</th> <th>Арт.</th> </tr> <tr> <td>DY 816</td> <td>100002356</td> </tr> </table>	∅110/150 мм	Арт.	DY 816	100002356															
∅110/150 мм	Арт.																		
DY 816	100002356																		
Коаксиальное колено с лючком для ревизии 	23	<table border="1"> <tr> <th>∅80/125 мм</th> <th>Арт.</th> </tr> <tr> <td>DY 875</td> <td>100008311</td> </tr> </table>	∅80/125 мм	Арт.	DY 875	100008311													
∅80/125 мм	Арт.																		
DY 875	100008311																		
Черепица с втулкой для выхода на крышу (для штампованной черепицы) 	22	<table border="1"> <tr> <th>Угол наклона : 30 - 45°</th> <th>Арт.</th> </tr> <tr> <td>DY 11</td> <td>84887411</td> </tr> </table>	Угол наклона : 30 - 45°	Арт.	DY 11	84887411													
Угол наклона : 30 - 45°	Арт.																		
DY 11	84887411																		
<table border="1"> <tr> <td>CX 49</td> <td>A</td> </tr> <tr> <td></td> <td>700</td> </tr> <tr> <td>DY 11</td> <td>880</td> </tr> </table>	CX 49	A		700	DY 11	880													
CX 49	A																		
	700																		
DY 11	880																		
<table border="1"> <tr> <th>Угол наклона : 40 - 55°</th> <th>Арт.</th> </tr> <tr> <td>CX 49</td> <td>84837729</td> </tr> </table>	Угол наклона : 40 - 55°	Арт.	CX 49	84837729															
Угол наклона : 40 - 55°	Арт.																		
CX 49	84837729																		
Защитная решетка из нержавеющей стали 	25	<table border="1"> <tr> <th>для ∅60/100 мм</th> <th>Арт.</th> </tr> <tr> <td>DY 166</td> <td>84887566</td> </tr> </table>	для ∅60/100 мм	Арт.	DY 166	84887566													
для ∅60/100 мм	Арт.																		
DY 166	84887566																		
<table border="1"> <tr> <td>DY 166</td> <td>A</td> <td>B</td> <td>C</td> </tr> <tr> <td></td> <td>154</td> <td>228</td> <td>170</td> </tr> <tr> <td>DY 865</td> <td>229</td> <td>260</td> <td>237</td> </tr> <tr> <td>DY 866</td> <td>254</td> <td>268</td> <td>270</td> </tr> </table>	DY 166	A	B	C		154	228	170	DY 865	229	260	237	DY 866	254	268	270			
DY 166	A	B	C																
	154	228	170																
DY 865	229	260	237																
DY 866	254	268	270																
<table border="1"> <tr> <th>для ∅80/125 мм</th> <th>Арт.</th> </tr> <tr> <td>DY 865</td> <td>100005002</td> </tr> </table>	для ∅80/125 мм	Арт.	DY 865	100005002															
для ∅80/125 мм	Арт.																		
DY 865	100005002																		
<table border="1"> <tr> <th>для ∅110/150 мм</th> <th>Арт.</th> </tr> <tr> <td>DY 866</td> <td>100005004</td> </tr> </table>	для ∅110/150 мм	Арт.	DY 866	100005004															
для ∅110/150 мм	Арт.																		
DY 866	100005004																		
Крепежный хомут 	29	<table border="1"> <tr> <th>∅125 мм</th> <th>Арт.</th> </tr> <tr> <td>CX 118 (короткий)</td> <td>84837718</td> </tr> <tr> <td>CX 79 (длинный)</td> <td>84837779</td> </tr> </table>	∅125 мм	Арт.	CX 118 (короткий)	84837718	CX 79 (длинный)	84837779											
∅125 мм	Арт.																		
CX 118 (короткий)	84837718																		
CX 79 (длинный)	84837779																		
<table border="1"> <tr> <td>CX 118</td> <td>A</td> </tr> <tr> <td></td> <td>125</td> </tr> <tr> <td>CX 79</td> <td>232</td> </tr> </table>	CX 118	A		125	CX 79	232													
CX 118	A																		
	125																		
CX 79	232																		
<table border="1"> <tr> <th>∅150 мм</th> <th>Арт.</th> </tr> <tr> <td>CX 111</td> <td>84827111</td> </tr> </table>	∅150 мм	Арт.	CX 111	84827111															
∅150 мм	Арт.																		
CX 111	84827111																		
Горизонтальное окончание для установки в существующий коаксиальный дымоход 		<table border="1"> <tr> <th>∅60/95 мм</th> <th>Арт.</th> </tr> <tr> <td>DY 912</td> <td>100017526</td> </tr> </table>	∅60/95 мм	Арт.	DY 912	100017526													
∅60/95 мм	Арт.																		
DY 912	100017526																		