

FITTINGS AND SWIVELS

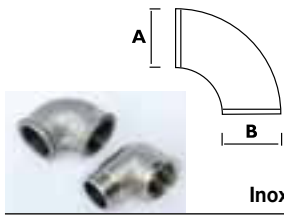

Elbows



Code	A BSP	B BSP		
F07806000	F 3/4"	F 3/4"		
F07805000	M 3/4"	F 3/4"		
F08609000	F 1"	F 1"		
F07988000	M 1"	F 1"		
Inox F14279000	M 1"	F 1"		

Hose tails

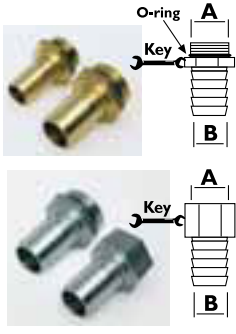

Code	A BSP	B	Q.ty	Key
F0826700A	1/2"	19	1	27
F06437000	3/4"	19	20	32
F0776800B	3/4"	25	20	32
F0775700A	1"	19	20	37
F0776400A	1"	25	20	37
Inox F14122000	M 1"	19	1	37
Inox F14123000	F 3/4"	19	1	37

Rotating hose tail - Inox

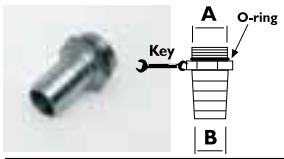

Code	A BSP	B	Key
F14132000	3/4"	19	30

Sleeve



Code	A	B	C
F08137000	28	20	30
F08138000	36	28	35

Sleeve



Code	A BSP	B BSP	C
F07766000	M 3/4"	M 3/4"	27
F07765000	M 1"	M 1"	34

Reducing sockets

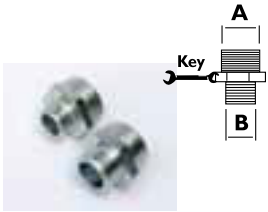

Code	A BSP	B BSP	Key
F07441000	F 1/2"	M 3/4"	30
F07762000	M 3/4"	M 1"	34
F08913000	M 1"	M 1 1/2"	50
F07760000	F 3/4"	M 1"	35
F07889000	F 1"	M 3/4"	34
009154000	F 1"	M 1 1/4"	47
008891000	F 1"	M 2"	60

Elbow rotating connector

Code F14567000



Foot valve

Code	Safety valve	Ø A	Ø B	Ø C	Key 1	Key 2	Quantity	Packaging
F00609000	•	-	1" BSP	-	38	-	1	
Ø 25 with filter								
F00612000	•	-	3/4" BSP	-	31	-	1	
Ø 20 with filter								
F15749000	•	1" BSP	-	-	-	42/46	12	
1" with built-in safety valve								
F07979000		-	-	1" BSP	-	-	1	
Foot valve								

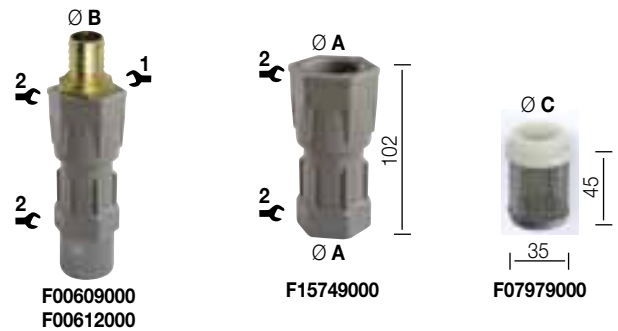

Swivel

rotating hose connectors

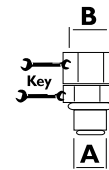

Code	Description	A BSP	B BSP	Key
845600A	Swivel 12.12	M 1/2"	F 1/2"	25
62000A	Swivel 34.1	M 3/4"	F 1"	94
62200A	Swivel 1.1 MF	M 1"	F 1"	38
623000	Swivel 34.1 MM	M 3/4"	M 1"	34
62400A	Swivel 34.34 MF	M 3/4"	F 3/4"	34

Union

re-usable coupling

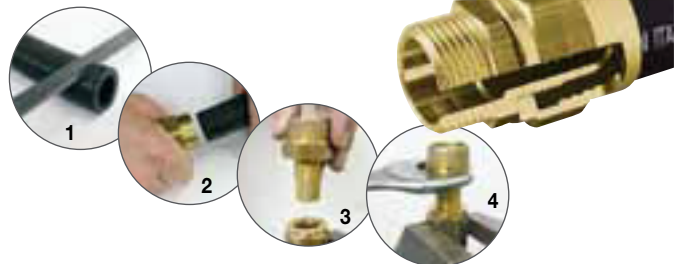

Code		A BSP	B mm	C mm	Key 1	Key 2
000890000	Union 34.27	3/4"	19	27	38	38
000891000	Union 1.27	1"	19	27	31	31
000892000	Union 1.35	1"	25	35	38	38
000893000	Union 34.32	3/4"	19	32	31	31
000894000	Union 1.32	1"	19	32	38	38
000895000	Union 1.38	1"	25	38	38	38

The Company reserves the right to modify the information contained in this catalogue without any prior notice.



Certified
ISO 9001 / ISO 14001

PIUSI S.p.A.
46029 Suzzara (Mantova) ITALY
Tel. +39-0376.534561
Fax: +39-0376.536393
e-mail: piusi@piusi.com
www.piusi.com

PIUSI USA, Inc.
2365 SW 34th St.
FORT LAUDERDALE, FL 33312, USA
Tel. : +1 954 584 1552
Fax.: +1 954 584 1554
e-mail: piusiusa@piusiusa.com
www.piusiusa.com

